

**AUSTRALIAN SYSTEMATIC BOTANY SOCIETY
NEWSLETTER NUMBER 30 (1982)**

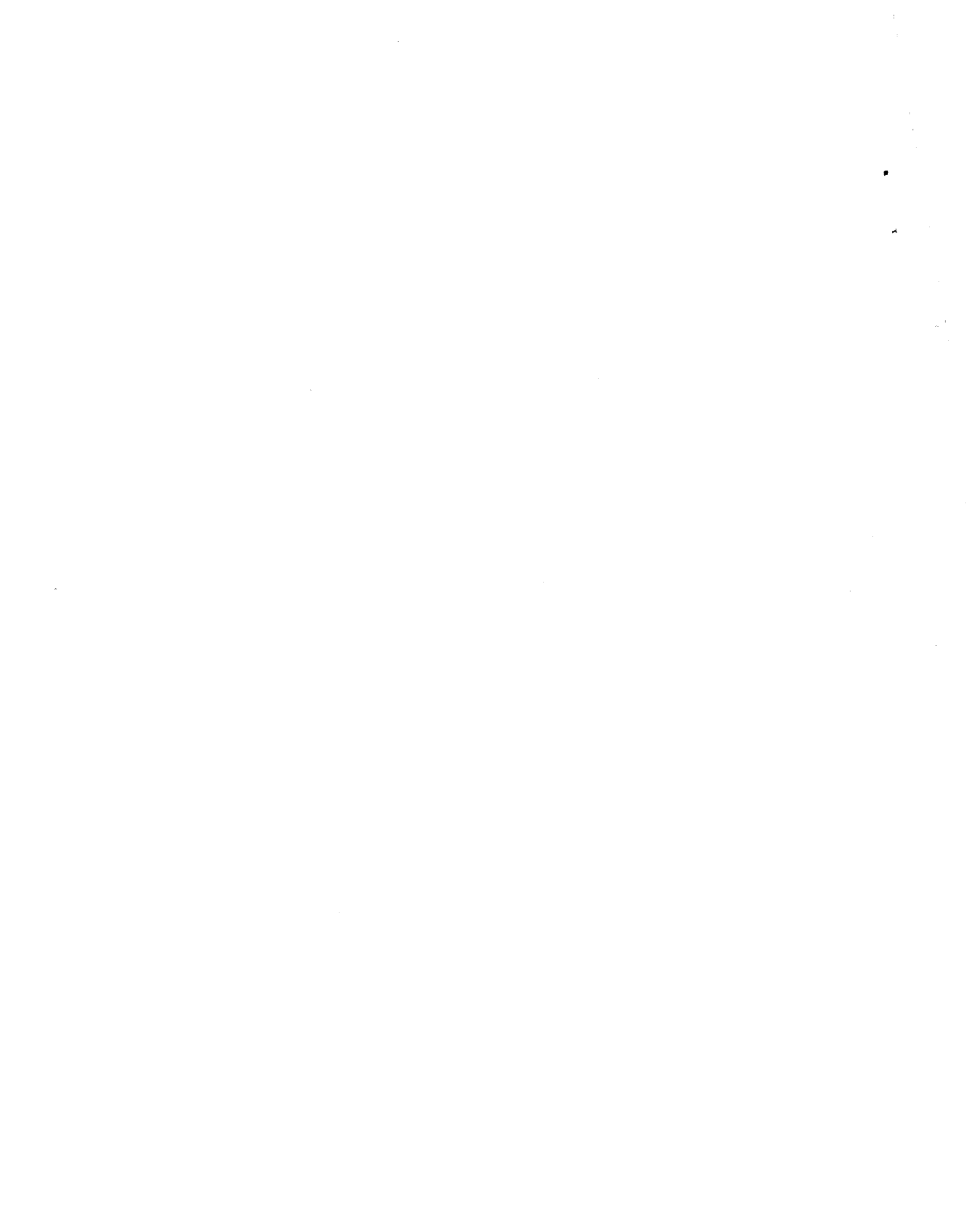



AUSTRALIAN SYSTEMATIC BOTANY SOCIETY

NEWSLETTER

Newsletter No. 30

February, 1982

The Newsletter is the official publication of
the Australian Systematic Botany Society.

A.S.B.S. COUNCIL

- President : Dr Trevor Clifford, Department of Botany,
St Lucia, Queensland, 4067.
- Vice-President : Dr Bryan Barlow, Herbarium Australiense, C.S.I.R.O.,
P.O. Box 1600, Canberra City, A.C.T. 2601.
- Secretary : Ms Judy West, Herbarium Australiense, C.S.I.R.O.,
P.O. Box 1600, Canberra City, A.C.T. 2601.
- Treasurer : Mr Barry Conn, Department of Botany, University of
Adelaide, Box 498, G.P.O., Adelaide, S.A. 5001.
- Councillors : Mr Laurie Haegi, National Herbarium of N.S.W.,
Royal Botanic Gardens, Sydney, N.S.W. 2000.
Mr Rod Henderson, Queensland Herbarium, Meiers Rd,
Indooroopilly, Queensland, 4068.

CONVENERS OF LOCAL CHAPTERS.

- ADELAIDE : Mr David Symon
ALICE SPRINGS : Mr John Maconochie
BRISBANE : Mr Laurie Jessup
CANBERRA : Dr Helen Hewsen
DARWIN : Dr Clyde Dunlop
HOBART : Dr Tony Orchard
MELBOURNE : Dr Dianne Simmons
PERTH : Dr Kingsley Dixon
ROCKHAMPTON :
SYDNEY : Dr Jocelyn Powell
TOWNSVILLE : Dr Betsy Jackes

Affiliated Society : Papua New Guinea Botanical Society.

INFORMATION FOR CONTRIBUTORS

The Newsletter is produced four times each year and deadlines for copy are the last day of February, May, August and November.

Please send contributions, preferably typed in duplicate and double-spaced, to the Editor, at the address below. Items from any source and of interest to members are acceptable. All items incorporated in the Newsletter will be duly acknowledged.

Please note: Next deadline for articles is 28 February, 1982

Editor
Barry Conn
Department of Botany
University of Adelaide
Box 498, G.P.O.
Adelaide, S.A. 5001.

SUBSCRIPTIONS

Subscriptions for 1982 were due on the 1st January. Both Australian and overseas members:

Aust. \$8.00 if paid by 31st March
Aust.\$10.00 thereafter.

Barry Conn
Treasurer.

Please note: Dr Gordon Guymer (Queensland Herbarium, Meiers Road, Indooroopilly, Queensland, 4068) will be the editor of the Newsletter for issue number 31 and subsequent issues.

INFLORESCENCE MORPHOLOGY

Introduction

The recent advances in the interpretation of the inflorescence morphology has not, in general, been seriously considered by English-speaking botanists. The typological system developed by W. Troll (for references refer other contributions in this issue) requires a rigorous analysis of the structure of the inflorescence, including a consideration of the developmental sequence. However, the complexity of Troll's system is compounded, at least for non-German speaking botanists, by the (seemingly) difficult style of the German text.

The contributions in this issue do not attempt to simplify or translate (even in part) 'Die Infloreszenzen' by Troll, but rather, it is hoped that these contributions will act as a stimulus, so that more botanists will attempt an evaluation of Troll's approach.

I have included a list (see below) of the terms abbreviated in the following contributions. Where there is no English equivalent, I have attempted to give a brief explanation. This listing is merely to assist those readers who are not familiar with the inflorescence terminology. Should rigorous explanations for any of these terms be required, the appropriate references should be consulted.

B.J. CONN

EXPLANATION OF ABBREVIATIONS USED IN CONTRIBUTIONS

BZ	field of enrichment, enrichment field or enrichment zone (Troll = Bereicherungszone).
CoF	Coflorescence (Troll = Cofloreszenz)
CoF', CoF''	Second and third order Coflorescences respectively. (Troll = Cofloreszenzen erster und höherer Ordnung).
EJ	Distal internode of main florescence (in Monotelic inflorescences) (Analogous to GJ of polytelic inflorescences) (Troll = Endinternodium nes Hauptsprosses).

GJ	Basal internode which separates the main florescence from the enriching field (Troll = Grundinternodium des Hauptsprosses).
HF	Main florescence (Troll = Hauptfloreszenz).
HZ	Field of Inhibition of main axis (Troll = Hemmungszone des Hauptsprosses).
HZ'	Field of Inhibition of paracladia (Troll = Hemmungszone der Parakladien).
JZ	Innovation zone (Troll = Innovationszone).
Pc	Paracladium - branches which repeat the structure of the main axis of the flowering system (Troll = Parakladium).
Pc', Pc'', Pc'''	Second, third, fourth order paracladium (Troll = Parakladien erster und höherer Ordnung).
PF	Partial florescence (Troll = Partialfloreszenz).
T	Terminal flower.
V	Front flower.

CURRENT PROBLEMS OF MODERN INFLORESCENCE MORPHOLOGY *

F. Weberling

Abt. Spezielle Botanik (Biologie V)
University of Ulm, Oberer Eselsberg, D-7900 Ulm, Germany.

If we want to draw systematical conclusions from the structure of inflorescences - e.g. those of the Caprifoliaceae, fig. 1 (Troll & Weberling 1966) or the whole Dipsacales (Weberling 1966) we must try to ascertain the flower bearing elements which may be compared as homologous and hence as legitimately comparable structures. This, however, is mutually connected with the elucidation of the structural plans of flowering plants. According to Troll the great diversity of inflorescences is due to the variation of two basic types only: the polytelic and the monotelic type.

In the *monotelic* inflorescence (fig. 2I) the apex of the inflorescence axis commonly ends with a terminal flower. This also applies to all the floral branches below the terminal flower. All of these branches, whether branched or not, proved to be homologous elements, and they all are referred to by the term '*paracladia*' because these branches repeat the structure of the main axis of the flowering system. The choice of the word *paracladium* (pl. *paracladia*) points to the observation, that the structure of inflorescences implies a regular repetition of equivalent elements according to a certain order. (So far the structure of inflorescences is a matter of symmetry and accessible to mathematical methods (Frijters 1976, Lindenmayer 1977)). Accordingly the ramifications of the *paracladia* are called *paracladia* of the 2nd to nth order. Since by the presence of the *paracladia* the number of flowers in the flowering systems is increased, they may be called '*enriching branches*'.

Consequently the whole area which produces the enriching branches may be designated as an '*enriching field*'. In the lower part of the flowering shoot this zone is commonly preceded by a '*field of inhibition*' within which the development of *paracladia* is inhibited more or less abruptly. The same zonation can be recognized in the individual *paracladia* if these are not reduced in any way. In perennials the axillary buds at the base of the whole stem do not develop within the same season, but will give rise to *innovation shoots* at the beginning of the following season. Therefore this area has to be distinguished as a '*field of innovation*'.

* Presented to the XIII International Botanical Congress, Sydney, 25.viii.1981.

The *polytelic* type of inflorescence (fig. 2II) probably has been derived repeatedly from the *monotelic* during the evolution of angiosperms by reduction of the terminal flower and specialization of the *paracladia* of the *monotelic* system. The distal elements are reduced to single lateral flowers or lateral cymes (*partial florescences*) which constitute elements of an apical system composed of lateral flowers only. This indeterminate apical flowering system is a constant feature of this type of inflorescence. Therefore it is referred to by the special term '*florescence*'. The lower lateral branches repeat the structure of the main stem by producing (indefinite) *florescences* themselves (*coflorescences*) and therefore may be termed *paracladia* (of the *polytelic* system).

Within these *polytelic* *synflorescences** the same zonation can be observed as in *monotelic* flowering systems: a *paracladial* zone: "*enriching field*" which precedes the main *florescence*, a "*field of inhibition*" and - in perennials - a "*field of innovation*". The *florescence* is separated from the *enriching field* by a "*basal internode*" ("*Grundinternodium*", Troll), which may be of remarkable length.

In both types the different elements may vary in many different quantitative respects according to the principle of variable proportions. Even so, the *inflorescences* of all species investigated (about 20,000 from nearly all angiosperm families) proved to fit into the typological concept elaborated by Troll. However, some problems, still require further detailed investigation, and some terminological questions must be discussed.

An essential difference between both types seems to be, that in the *inflorescences* of the *polytelic* type the shoot apex of the *inflorescence* axis remains indeterminate. This, however, also occurs in some *monotelic* *inflorescences* in which the terminal flower aborts. In such truncate *monotelic* *synflorescences*, however, the *paracladia* usually end in terminal flowers, thus revealing the *monotelic* character of the whole system.

* *synflorescence*: a system of *florescences* or a system of a terminal flower and *monotelic* *paracladia*.

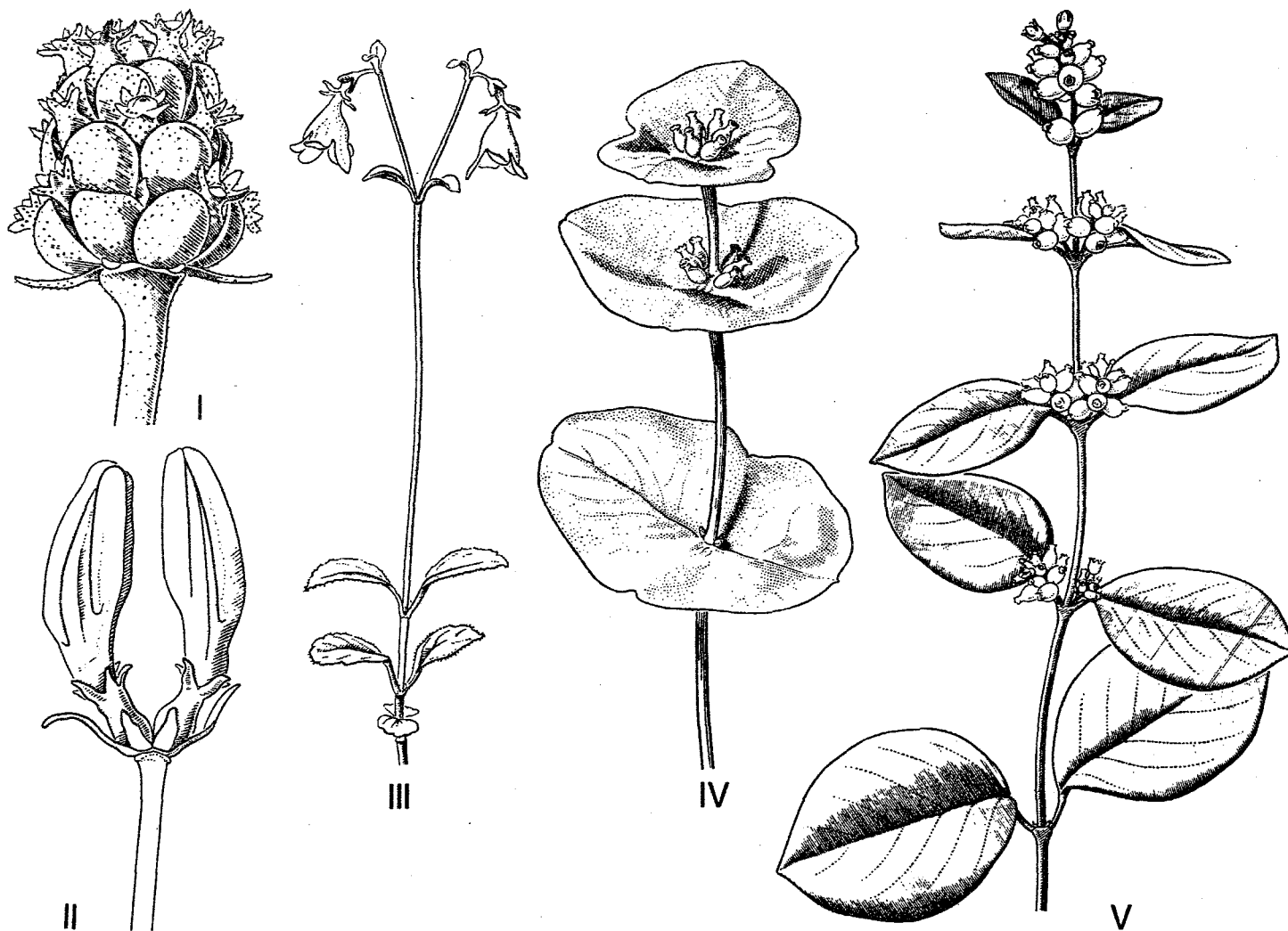

Fig. 1: Inflorescences of some Caprifoliaceae. I *Lonicera periclymenum* L., II *L. tatarica* L., III *Linnaea borealis* L., IV *Lonicera caprifolium* L., V *Symphoricarpos rivularis* SUKSD.

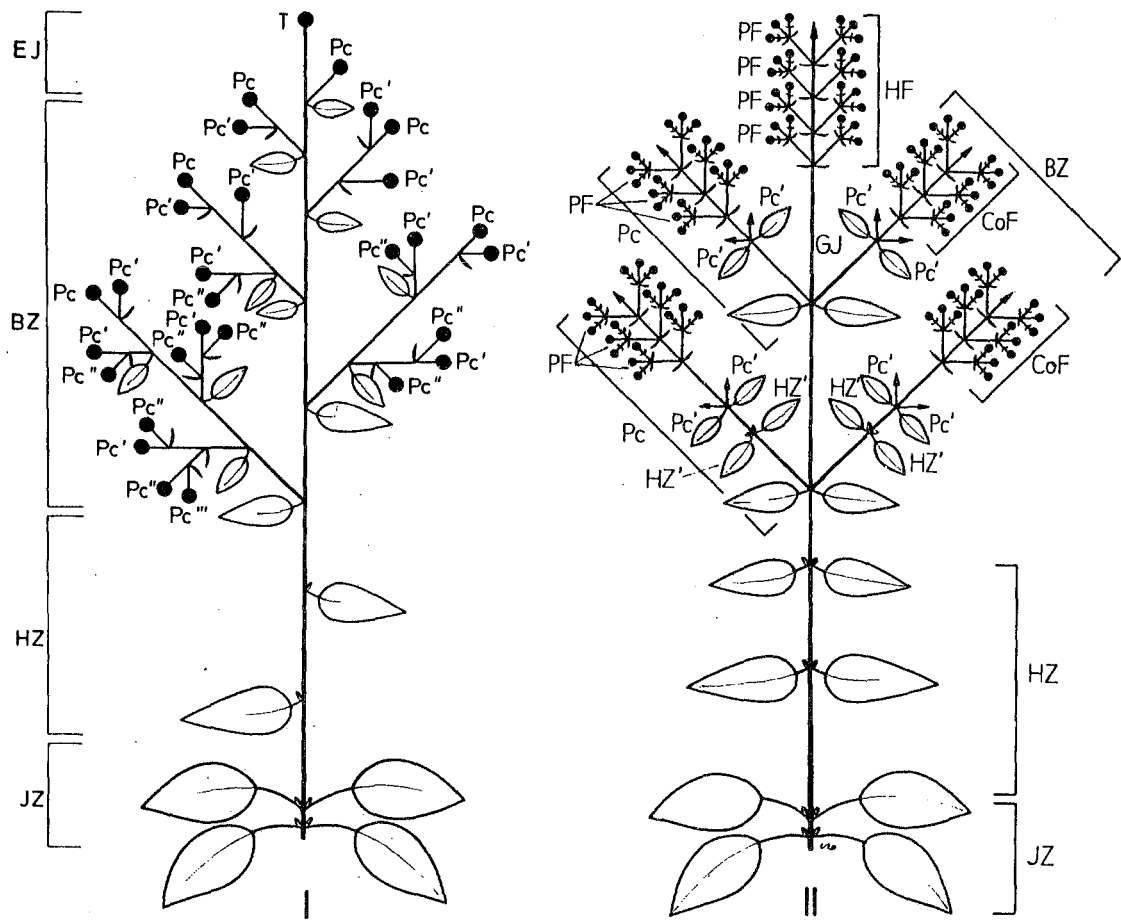

Fig. 2: Diagrams of a monotelic (I) and a polytelic (II) inflorescence T, terminal flower; PC; paracladium; Pc', Pc'', Paracladia of 2nd and 3rd order; HF, main-florescence; ('Hauptfloreszenzen'); Co F, co-florescence; PF, partial florescence; GJ, basal internode ('Grundinternodium'); EJ, final internode ('Endinternodium'); BZ, field of enrichment ('Bereicherungszone'); HZ, field of inhibition ('Hemmungszone'); JZ, field of innovation ('Innovationszone').

The terminal flower of a monotelic system may be stunted or missing because the primordia of the uppermost paracladia "comprise the whole of the apex, leaving no residuum to continue the growth of the axis". This statement is given by Philipson (1947) for *Valeriana officinalis*, where the terminal flowers are missing in all paracladia of thyrsoid structure. As another example *Linanthus liniflorus*, belonging to the Polemoniaceae, may be mentioned here. In this case the terminal flowers are often more or less rudimentary.

In other examples, such as some species of *Loeselia* (Polemoniaceae) or in *Agrimonia eupatoria* the development of the vigorous distal part of the inflorescence often takes a very long time and very often remains incomplete, thus the terminal flower is failing in the main axis of the inflorescence. This, however, is not the case in the paracladia, which are less vigorous. Examples like these call our attention, when we consider the aspect of the inflorescence-evolution.

In many lianas or rosette geophytes the growth of the main axis is indefinite. Thus the main axis, though it may produce lateral flower bearing branches, never ends in a terminal flower. This may be demonstrated here by two closely related Rubiaceae, *Sabicea laxothyrsos* and *Bertiera letouzeyi*. The latter is a liana. In contrast to *Sabicea* it does not produce a terminal flower. Rosette geophytes with indefinite main axes are represented by many species of *Plantago* and the species of the genus *Phyllactis* (Valerianaceae). Here the apex of the rosette changes periodically from the formation of absolutely sterile zones and the formation of fertile regions, in which thyrsoid partial inflorescences originate from the axils of the rosette leaves. Later, I will further discuss this mode of growth commonly called "proliferation".

Comparing the two types of inflorescences we conclude, that the polytelic type is more highly evolved than the monotelic. There is much evidence that the polytelic type is derived from the monotelic by two steps of evolution:

1. reduction of the terminal flower and
2. specialization of the lateral branches, some of which are reduced to single lateral flowers or lateral cymes which constitute elements of the florescences while the other branches are differentiated as paracladia (of the polytelic type!) which themselves form florescences.

This evolution has taken place in different taxa of the angiosperms, sometimes even in several groups of the same family (e.g. Rubiaceae). Though both steps -reduction of the terminal flower and specialization of the lateral branches - may occur independently from each other, the way of evolution usually indicated by transitional forms is that of "homogenization", mostly combined with racemization (Maresquelle 1970 a.o.* , Sell 1969, 1976 a.o.) and then "truncation", the reduction of the terminal flower (fig. 3).

The process of *homogenization* produces an increasing uniformity of the lateral branches within the distal parts of the flowering system which constitute the florescences in the polytelic synfloreences. Whereas in the monotelic synfloreences the terminal flower usually demonstrates its somewhat dominant position by blooming at least before the neighbouring lateral flowers, now the sequence of flowering within the distal flower bearing systems show a reversion of efflorescence. Finally the efflorescence within the presumptive florescences follows the way of the initiation of the flowers advancing from base to apex. The result of this process of *racemization* is that the last flowers of the florescence often do not complete their development and atrophy; at least the terminal flower is reduced: *truncation* (see also: Weberling 1961, 1965, Troll & Weberling 1966).

Following this argument one can assume, that the starting point of inflorescence-evolution must have been the (monotelic) panicle. By studying the primitive families of the Magnoliales (and Dilleniales), however, one only finds poor evidence for this assumption. The inflorescences of most taxa within these families are relatively highly derived by specialization in long shoots and flower bearing short shoots or by proliferation. It is not rare that they are already of polytelic type. Thus it seems to be more advisable to accept the panicle as "central type" only, from which all the other forms of inflorescences can be derived. This does not necessarily imply a phylogenetical interpretation. Some previous authors, as Parkin (1914, 559) pointed out, that "it seems highly probable that *flowers were originally borne on "the plant singly, each terminal to a leafy shoot."* We find such flowers in *Liriodendron* (fig. 4I), many *Magnolias*, *Calycanthus* and others. These could as well represent a state close to the starting point of inflorescence-evolution (though we have to pay attention to the fact, that single flowers also "may have arisen through the reduction of an inflorescence").

* a.o. = and other publications by the same author which are not, however, cited in this paper.

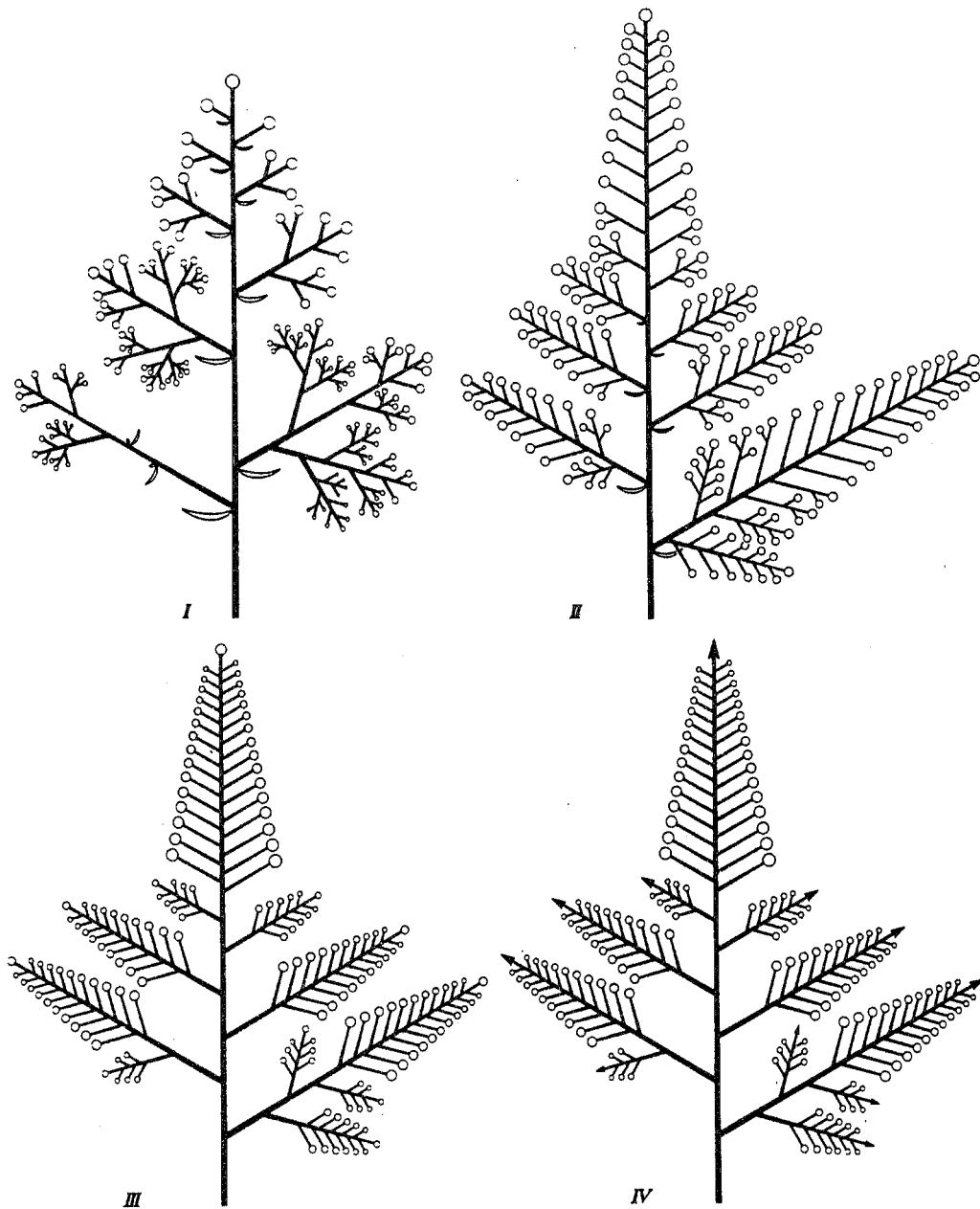

Fig. 3: Derivation of the polytelic type of inflorescences (IV) from the monotelic (I). I panicle (e.g. *Polemonium sibiricum*), II "homogenization" within the distal parts of the branches of a panicle (e.g. *Gilia capitata*), III "racemization", IV "truncation" (reduction of the terminal flowers).

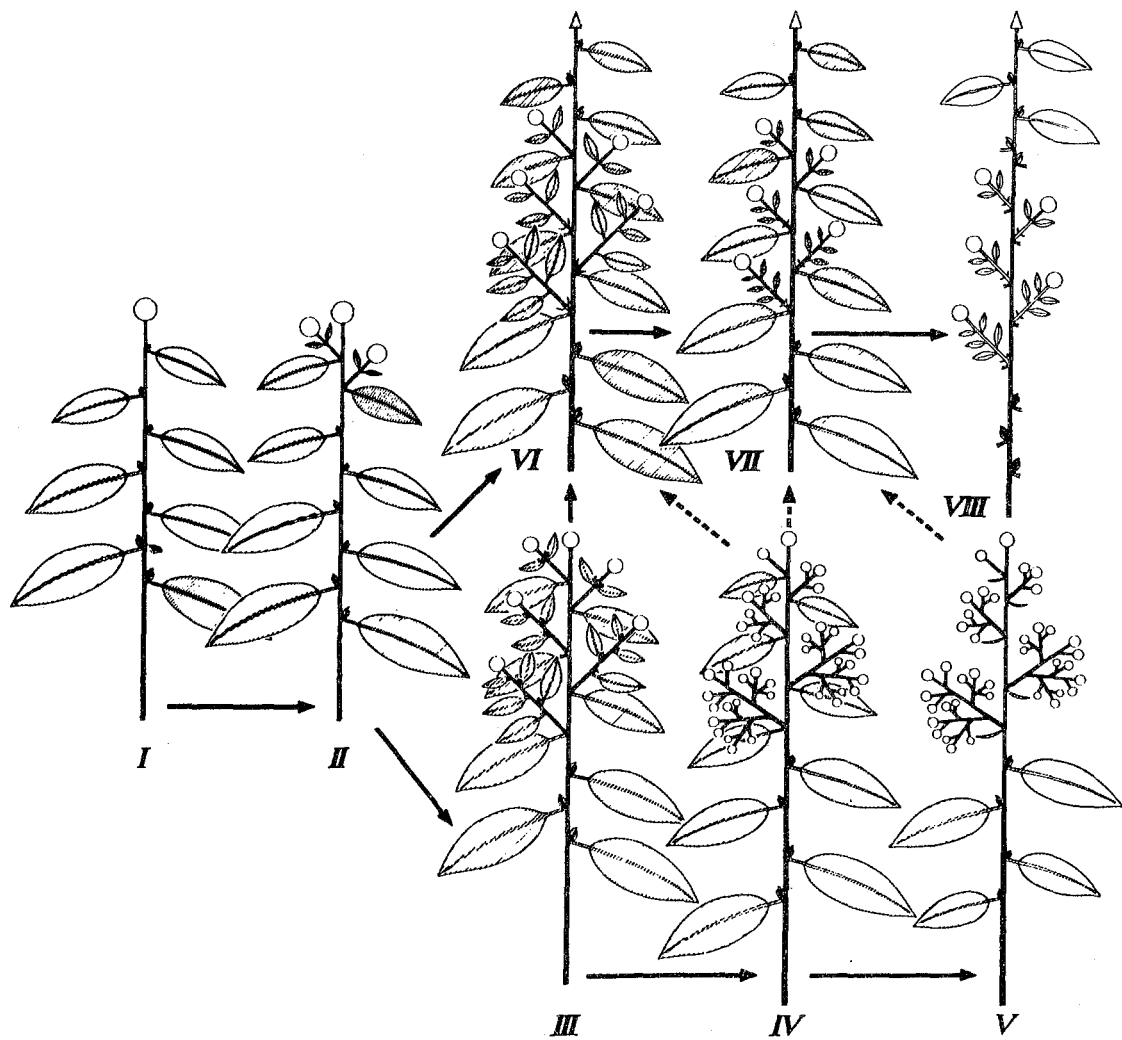

Fig. 4: Diagrams to illustrate the hypothesis of PARKIN on inflorescence-evolution (I-V), and to explain the formation of proliferating inflorescences (VI) and the differentiation of the shoot system into long shoots and short shoots which either develop synchronously with the long shoot and flower within the same season (VII) or develop and flower in the next season (VIII).

According to Parkin (1914, 519) one could assume "a hypothetical tree or shrub which has groups of foliage shoots each axis of which is terminated by a single flower." In the next step of evolution as assumed by Parkin "the leafy shoots bearing flowers tend to arrange themselves in groups". If then shortening of these shoots and the reduction of all foliage leaves to bracts" takes place, the "group of flowering shoots would now become an inflorescence". I have tried to explain this by the diagrams in fig. 4II-V. Parkin supposes, however, that this might not have been the general way of evolution. It seems to be more likely to him, that the majority of inflorescences might have arisen "by the production *de novo* of lateral flowers alongside the terminal one".

Pilger (1922, 21) said (in translation): The most primitive form of the inflorescence in angiosperms is the leafy panicle: only the separation of leafy and flowering branches, respectively, of such seasonal shoots leads to a more distinct delimitation of inflorescences.

This statement refers to woody plants especially. We must emphasize, however, that the zonation of a flowering system, which has been described here for the inflorescences of both types, is in principle the same for herbaceous and woody plants. Nevertheless in woody plants of tropical regions the delimitation of an inflorescence and consequently the identification of homologous elements may be difficult. This is largely due to the fact, that in contrast to woody plants of the temperate and subtropical zones, which develop distinct renewal shoots from the axils of the leaves below the terminal inflorescence, the synchronous (sylleptic) development and flowering of branches characteristic of many tropical trees and shrubs sometimes makes it difficult to clearly delimit between, for example, the inflorescence and the preceding "hypotagma" (= Unterbau", Troll 1964, 180). In such cases, it becomes difficult to determine the position of a flower bearing system so that it is equivalent (comparable) to that of other taxa.

The development of seasonal shoots, so characteristic for woody plants of the temperate zones, is often combined with a specialization between vegetative and flower producing shoots. This division of labour can also be observed in tropical woody plants and in some herbaceous plants (*Tussilago*, *Petasites*).

In woody plants we often find a differentiation of the shoot system into long shoots and short shoots. Here the production of flowers is often limited to the short shoots situated in the axils of the long shoots, while the long shoots by their "proliferating" growth contribute to the expansion of the whole branching system (fig. 4II-VII). Perhaps *Degeneria vitiensis* might be a good example for fig. 4II. Especially in the temperate regions (but not limited to them) the short shoots commonly develop and flower in the year that follows the development of the long shoot (fig. 4VIII). Thus - except in evergreen plants - at the blossom time of the whole branch the long shoot has already lost its leaves.

The problem of delimitation of comparable flower bearing parts may be explained by two examples, *Weigela* and *Symphoricarpos*.

Superficially, a flowering branch of *Weigela* (fig. 5I) might look like a polytelic synflorescence with an apical main florescence and lateral paracladia ending in co-florescences. We must, however, notice, that the foliation of the flower bearing branches as well as of the apical flowering system is preceded by a series of bud scales. On the other hand the main branch of the whole flowering system has lost its leaves already. Our interpretation is, that we have to deal here with flower bearing short shoots situated in terminal and lateral positions on last years long shoot. Each short shoot has to be regarded as a flowering system by itself. Comparative studies, suggest that their inflorescences can be interpreted as greatly reduced monotelic synflorescences, originally with thyrsoid ramification.

Looking at a flowering branch of *Symphoricarpos rivularis* now, (fig. 5II), we observe a leafy foliation throughout the whole branching system with the exception of the distal parts. Since all the flower bearing branches are indefinite, the whole flowering system could be interpreted as a polytelic synflorescence with the spike-like florescences (representing reduced thyrses). The lateral flowering systems, however, though blooming synchronously with the terminal inflorescence are provided with one or several pairs of scale-like leaves at their bases, which actually function as bud scales for a short time. Thus we may assume, that the lateral flower bearing shoots are short shoots which develop and flower without a preceding period of rest. This would not allow us to regard them as paracladia of the same flowering system. The scale-like leaves, however, though temporarily functioning as bud scales, may bear flowers in their axils too. All this seems to indicate that we have to deal with the intermediate forms between a sylleptic branching system flowering more or less synchronously and the differentiation into long shoots and (cataleptic*) short shoots. The same is verified by the whole genus *Symphoricarpos*, within which we observed many transitional forms.

* see: D. Müller-Doblies, Ber. Schweiz. Bot. Ges. 85: 177-178 (1975).

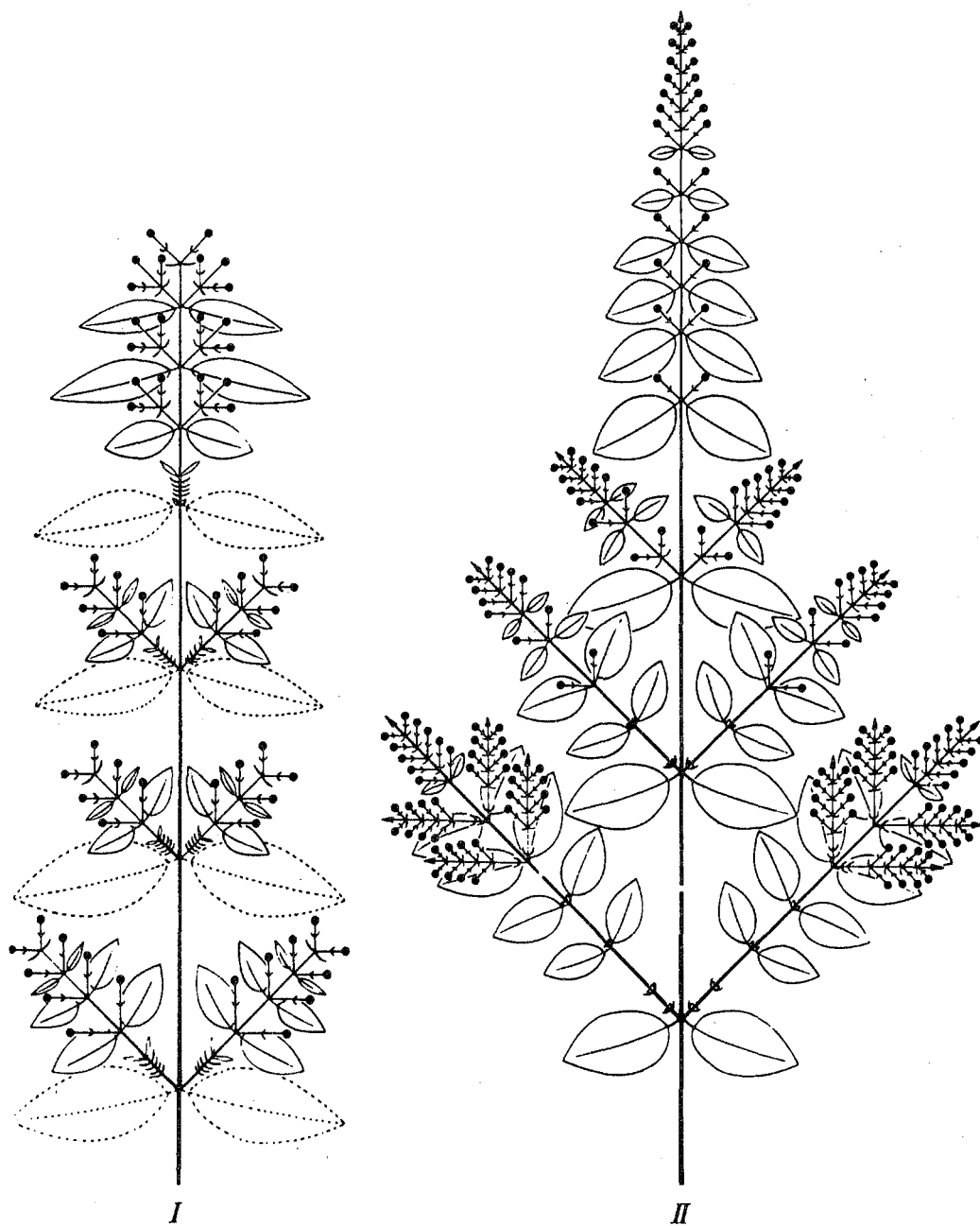

Fig. 5: Diagrams of flowering branches of *Weigelia floribunda* (SIEB. & ZUCC.) K. KOCH (I) and *Symphoricarpos rivularis* SUKSD. (II).

With regard to the typology of inflorescences which was explained before, we may confirm, that the species of *Symphoricarpos* represent a state of transition between the monotelic and the polytelic type.

These statements may be unsatisfactory for people who expect a definite assignment of all forms of inflorescence. In this situation we must remember, that the aim of comparative morphology is to elucidate relationships of forms and not to serve as a 'chest of drawers' in which each organic form has a definite place.

In the elucidation of morphological relationships, which have been used in an attempt to resolve systematical problems, the application of the typological concept of Troll has already proved to be useful. This also applies to the inflorescences of the Caprifoliaceae which initially appear to be fundamentally different within the Caprifoliaceae (fig. 1): pyramidal panicle-like pleio-thyrse in *Sambucus* Sect. *Botryosambucus* (e.g. *S. racemosus*), umbel-shaped pleio-thyrse in *Sambucus* Sect. *Sambucus* (e.g. *S. nigra*, *S. australasica*) and in *Viburnum* (here the marginal flowers often with enlarged corollas), simple thyrse in *Diervilla* and others, racemes in *Symphoricarpos* (fig. 1V), head-like inflorescences in *Lonicera periclymenum* (fig. 1I), "sessile whorls" in *L. caprifolium* (fig. 1IV), "paired flowers" in *Lonicera tatarica* (fig. 1III) and other species of the subgenus *Lonicera*, which appear to be similar to the flower pairs of *Linnaea borealis* (fig. 1III).

All these inflorescences, however, can be derived from a monotelic pleio-thyrse as for example represented by *Sambucus racemosus*. The inflorescences of *Sambucus* and *Viburnum* are monotelic, though highly specialized in certain directions. In *Diervilla* the monothyrse inflorescences sometimes still bear a terminal flower. Mostly, however, the inflorescence is truncate as is the case in many other genera. In *Lonicera* the transition to a polytelic inflorescence is complete. The best example for this is *Lonicera etrusca*. Fig. 6I shows a fully developed inflorescence with a thyrse main-florescence and thyrse co-florescences. The partial florescences commonly are three-flowered but may bear seven flowers as well. By reduction of the primary flower twin-flowered partial florescences are formed*.

* transitional forms have been observed in *L. tatarica*.

Twin-flowered partial florescences are characteristic for the subgenus *Lonicera*. In many species of this subgenus these partial florescences appear somewhat isolated, since the subtending leaves ("Tragblätter"; pherophylls, Briggs & Johnson 1979) are frondose, and often the inflorescence is proliferating. These species are often described as having "twin-flowered inflorescences", thus suggesting an equivalence to the "axillary pairs" with the inflorescences of the other genera. In contrast to the species of *Lonicera* subgenus *Lonicera* the twin-flowered inflorescences of *Linnaea borealis* result from a reduction of a truncate thyrse inflorescence terminating a short shoot. In rare cases these inflorescences can develop more than one pair of flowers (fig. 6IVa). The same structure can be found in some species of the closely related genus *Abelia* (fig. 6V).

Some confusion in the valuation of flowering systems may also result from the proliferation of certain inflorescences. This peculiarity has been mentioned already in connexion with the fact that the inflorescence axis may remain indefinite. Certainly it does not seem advisable to refer the term proliferation to the unlimited growth of any shoot bearing leafy branches which may after further ramifications finally produce flower bearing elements. In the sense used by Troll (1959, 116) it means a return of the inflorescence apex to vegetative growth. In *polytelic synflorescences* this may happen early, before the initiation of the main florescence: proliferation of the paracladial zone ("Frühprolifikation", Troll). As an example *Lysimachia thyrsoiflora* may be mentioned here. Proliferation may also take place later, such that the apex of the main florescence reverts to vegetative growth: proliferation of the florescence ("Spätprolifikation", Troll). This applies to *Lysimachia punctata* and *L. nummularia*, to *Glaux maritima* and to *Eucomis punctata* and other monocotyledons. Proliferation may also occur in monotelic synflorescences (some species of *Campanula*, some Boraginaceae, Myrtaceae).

Parkin (1914, 556) regarded proliferating inflorescences as a separate type of inflorescence, which he called *intercalary inflorescences*, because "the flower-bearing part of the axis is ... intercalated between two foliage-bearing portions". We must emphasize, however, that there are many taxa (*Veronica*, *Lysimachia*, and others) which have species with terminal bracteose and terminal foliose inflorescences as well as species with proliferating leafy inflorescences. Often these forms are connected by continuous series of intermediate forms. At least in these cases we must regard these proliferating inflorescences as highly derived from terminal ones. This - in my opinion - refers as well to the myrtaceous genera *Melaleuca*, *Callistemon* and *Calothamnus*.

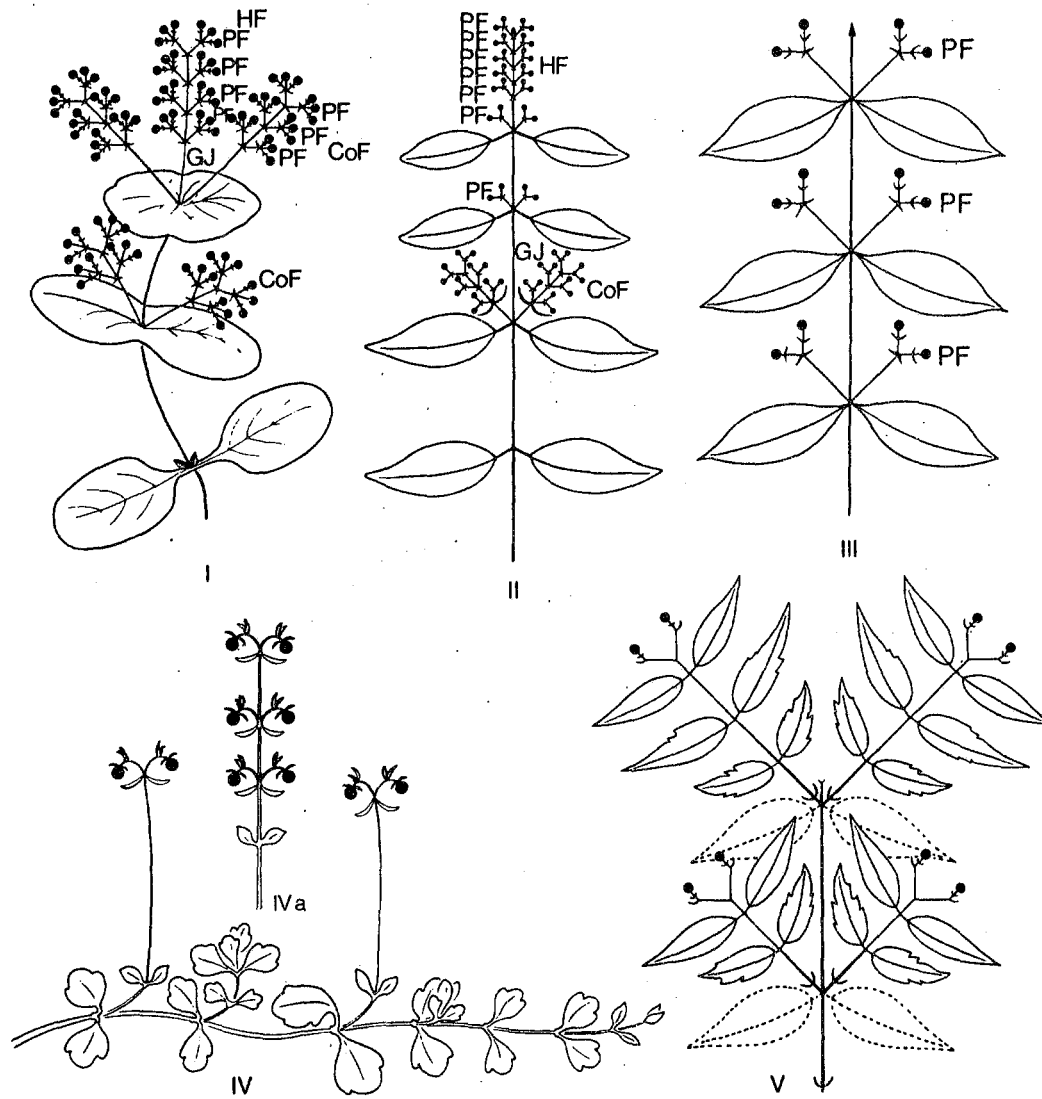

Fig. 6: Diagrams of the inflorescences of *Lonicera etrusca* SANTI (I), *L. affinis* HOOK. et ARN. (II), *L. tatarica* L. (III), *Linnaea borealis* L. (IV, IVa showing a six-flowered inflorescence), and *Abelia biflora* TURCZ.

In the examples mentioned here the proliferation takes place after or during the effloration of the inflorescence. The effloration, however, may be delayed somewhat more, thus giving a strong impression of an "intercalary" position of the inflorescence. The connexion with the formation of cataleptic flower bearing short shoots seems to be obvious here. In some evergreen plants the effloration of the flower bearing elements may be irregular (e.g. *Hakea cucullata* R. Br.). These examples demonstrate that it is advisable to include the factor time into future investigations more thoroughly. This refers to several inflorescence structures, some of which will be a subject of the contribution of U. & D. Müller-Doblies.

Another problem is that of perennial inflorescences as we find them e.g. in *Mitrophyllum grande* (Mesembryanthemaceae). This case, however, has caused controversial opinions (Poppendieck 1976). Pluriannual inflorescences have not only been reported for Aizoaceae (Troll & Weberling 1981), but also from Chenopodiaceae and probably will be reported from other families too. We need to study them more in detail. Though the controversies mentioned here and other questions still open to discussion do not principally affect the typological concept elaborated by Troll, there still remains much research to be done.

References

- BRIGGS, B. & JOHNSON, L. Evolution in the Myrtaceae - evidence from inflorescence structure. Proc. Linn. Soc. New South Wales 102: 157-272. 1979.
- FRIJTERS, D.H.M. Control mechanisms and computer descriptions of inflorescence development. Thesis, Rijksunivers. Utrecht, 1976.
- LINDENMAYER, A. Paracladial relationships in leaves. Ber. Dtsch. Bot. Ges. 90: 287-301. 1977.
- MARESQUELLE, H.J. Le thème évolutif des complexes d'inflorescences. Son aptitude á susciter des problèmes nouveaux. Bull. Soc. bot. Fr. 117: 1-4. 1970.
- PARKIN, J. The evolution of the inflorescence. J. Linn. Soc., Bot. 42: 511-563. 1914.
- PILGER, R. Bemerkungen zur phylogenetischen Entwicklung der Blütenstände. Bericht d. Freien Vereinigung f. Pflanzengeographie und systemat. Botanik für das Jahr 1919, 69-77 Berlin. 1921.

Ueber Verzweigung und Blütenstandsbildung bei den
Holzgewächsen. Bibl. Bot. Heft. Stuttgart, Vol 90.
1922.

POPPENDIECK, H. -H. Untersuchungen zur Morphologie und Taxonomie
der Gattung *Mitrophyllum* Schwantes s. -lat. Bot. Jahrb.
Syst. 97: 339-413. 1976.

RICKETT, H.W. The classification of inflorescences. Bot. Rev. 10:
187-232. 1944.

SELL, Y. Les complexes inflorescentiels de quelques Acanthacées.
Etude particulière des phénomènes de condensation de
racémisation, d'homogénéisation et de troncation.
Ann. Sci. Nat. Bot. 12: Sér. 10. 225-300. 1969.

Tendances évolutives parmi les complexes inflorescentiels.
Rev. gén. Bot. 83: 247-267. 1976.

TAKHTAJAN, A. Die Evolution der Angiosperm (dt. Übers. v. W. Höppner).
Jena. 1959.

TROLL, W. Über den Infloreszenzbegriff und seine Anwendung auf die
krautige Region blühender Pflanzen. Abh. Akad. Wiss.
Lit. Mainz, math. -nat. Kl. Nr. 15. 1950a.

in TROLL, W. u. WEBER, H. Morphologie einschliesslich
Anatomie, IV. Infloreszenzen. Fortschr. d. Botanik
17: 36-42. 1955.

Cochliostema odoratissimum Lem. Organisation und
Lebensweise, nebst vergleichenden Ausblicken auf
andere Commelinaceen. Beitr. Biol. Pflanzen 36:
325-389. 1961.

Die Infloreszenzen. Typologie und Stellung im Aufbau
des Vegetationskörpers, Bd. I, II. 1. Jena 1964/69.

Kommission für biologische Forschung. Bericht. Akad. Wiss. Lit. Mainz, Jb. 1950, 31-36; 1951, 36-38; 1952, 39-43; 1953, 39-45; 1954, 38-44; 1955, 39-46; 1956, 36-42 (1957); 1957, 39-50 (1958); 1958, 127-144 (1959); 1959, 112-131 (1960); 1960, 81-96 (1961); 1961, 113-126 (1962); 1962, 86-104 (1963); 1963, 113-137 (1964); 1964, 93-111 (1965); 1965, 109-133 (1966); 1966, 115-132 (1967); 1967, 89-103 (1968); 1968, 88-109 (1969); 1969, 82-101 (1970); 1970, 109-123 (1971); 1971, 107-127; (1972); 1972, 98-109 (1973); 1973, 135-151 (1974); 1974, 128-142 (1975).

TROLL, W. und WEBERLING, F. Die Infloreszenzen der Caprifoliaceen und ihre systematische Bedeutung. Abh. Akad. Wiss. Lit. Mainz, math. -nat. Kl. Nr. 5. 1966.

und Weberling, F. Infloreszenzstudien an Aizoaceen, Mesembryanthemaceen und Tetragoniaceen. Abh. Akad. Wiss. Lit. Mainz, math. -nat. Kl., Tropische und Subtropische Pflanzenwelt Nr. 35. 1981.

WEBERLING, F. Die Infloreszenzen von Bonplandia Cav. und Polemonium micranthum Benth. und ihre vermeintliche Sonderstellung unter den Blütenständen der Polemoniaceae. Beitr. Biol. Pflanzen 34: 195-211. 1957.

Die Infloreszenzen der Valerianaceen und ihre systematische Bedeutung. Abh. Akad. Wiss. Lit. Mainz. math. -nat. Kl. Nr. 5. 1961.

Homologien im Infloreszenzbereich und ihr systematischer Wert. Ber. Dt. Bot. Ges. 76: 1. Gen. vers. H., 102-112. 1963.

Typology of inflorescences. J. Linn. Soc. (Bot.) (London) 59: 215-221, 1 Taf. 1965.

Die Bedeutung der Infloreszenzmorphologie für die Systematik. Ber. Dt. Bot. Ges. 84: 179-181. 1971.

Beiträge zur Morphologie der Rubiaceen-Infloreszenzen. Ber. Dt. Bot. Ges. 90: 191-209. 1977.

EVOLUTION AND RADIATION OF THE PAIR-FLOWERED CYME IN GESNERIACEAE*

Anton Weber

Institute of Botany, University of Vienna
Rennweg 14, A-1030 Vienna, Austria.

Abstract

The "pair-flowered cyme" (each cyme unit bearing a flower pair instead of a single flower) is the basic element in the inflorescence architecture of Gesneriaceae. Its crucial morphological status is discussed and the hypothesis advocated that it is a structure preceding the conventional cyme in a reduction series starting from a panicle-like system. Consequently, the pair-flowered cyme may be regarded as phylogenetically more primitive than the ordinary cyme as it occurs commonly in the related Scrophulariaceae. Within the family, the pair-flowered cyme has undergone many structural and positional modifications. The various forms and variations are briefly surveyed, pointing out in particular progressive developments.

The special nature of the inflorescence of Gesneriaceae has for long escaped attention in the botanical literature; in fact, it is quite impossible to trace accurate information on this topic in the classical family monographs of Clarke (1883) and Fritsch (1893) or in the descriptions and diagnoses of most taxa. The inflorescences are said to be panicles, umbels, capitules, racemes, cymes, solitary flowers etc., and are said to occur in axillary or terminal positions. Thus the impression is left that there is no morphological coherence and specificity in regard to the inflorescence organisation in Gesneriaceae.

This large family, comprising more than 2500 species, indeed displays an enormous diversity in its inflorescence architecture. Nevertheless, in recent years, my own studies and data presented by some other authors (e.g. Troll 1964, Burt 1971, Wiehler, in press) have shown that this diversity can be reduced to one fundamental pattern only: a polytelic synflorescence composed of pair-flowered cymes.

*

Presented to the XIII International Botanical Congress,
Sydney, 25.viii.1981.

According to Troll (1964)¹, "polytelic" means that the main axis bearing the "main florescence", is indeterminate and does not produce a terminal flower. The same holds true for the so-called "paraclydia" which arise laterally below the main florescence and which bear the "co-florescences". Together the main and the co-florescences constitute the "synfloreescence". The florescences themselves are composed of subordinate, lateral units: simple flowers or "partial florescences".

In Troll's concept, the partial florescences are necessarily ordinary cymes, each unit being terminated by one flower (for an example refer to *Scrophularia*; Troll 1964: 67, 68, 386). But it is not as simple in Gesneriaceae: the partial florescences indeed branch cymosely, but each cyme unit ends with two flowers, in that the "true" terminal flower is accompanied by a subsidiary flower which arises without a bract at or slightly above the level of the lateral bracts (prophylls) in median position (fig. 1). For this additional flower the term "front-flower" is used in the following and the whole cyme is called a "pair-flowered cyme".

Strangely enough, this peculiar cyme type has been largely overlooked or ignored by taxonomists in the past, though it is found throughout the family, as well as in a few members of the related Scrophulariaceae: in the *Penstemon*- and *Calceolaria*-alliance, in *Tetranema* and *Russelia*.

The present paper is exclusively devoted to this pair-flowered cyme and shall refer to its morphological interpretation and presumed evolutionary origin, its modifications and progressive developments. A treatment of the gesneriaceous inflorescence as a whole, that is covering also the florescence and synfloreescence architecture, cannot be presented here.

INTERPRETATION, DEVELOPMENT AND PRESUMED ORIGIN OF THE PAIR-FLOWERED CYME

The presence of "supernumerary" flowers in the gesneriaceous cyme and their bractless origin are morphologically difficult to understand. Several, and contradictory, interpretations appear feasible:

¹ Troll's terminology has been adopted in analyzing Gesneriaceae and related families, as it allows a clear and precise description and evaluation of complex inflorescences and an accurate reference to homologous parts. It should be noted that the adoption of the terminology is irrespective of the acceptance of Troll's synfloreescence concept in its claim of universal applicability and validity. It simply works in the present plant group.

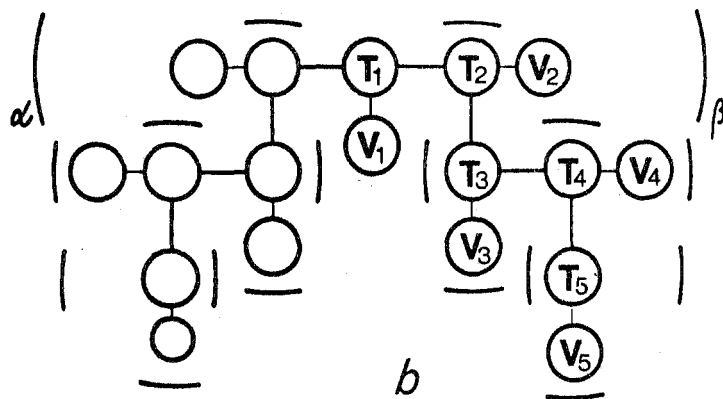
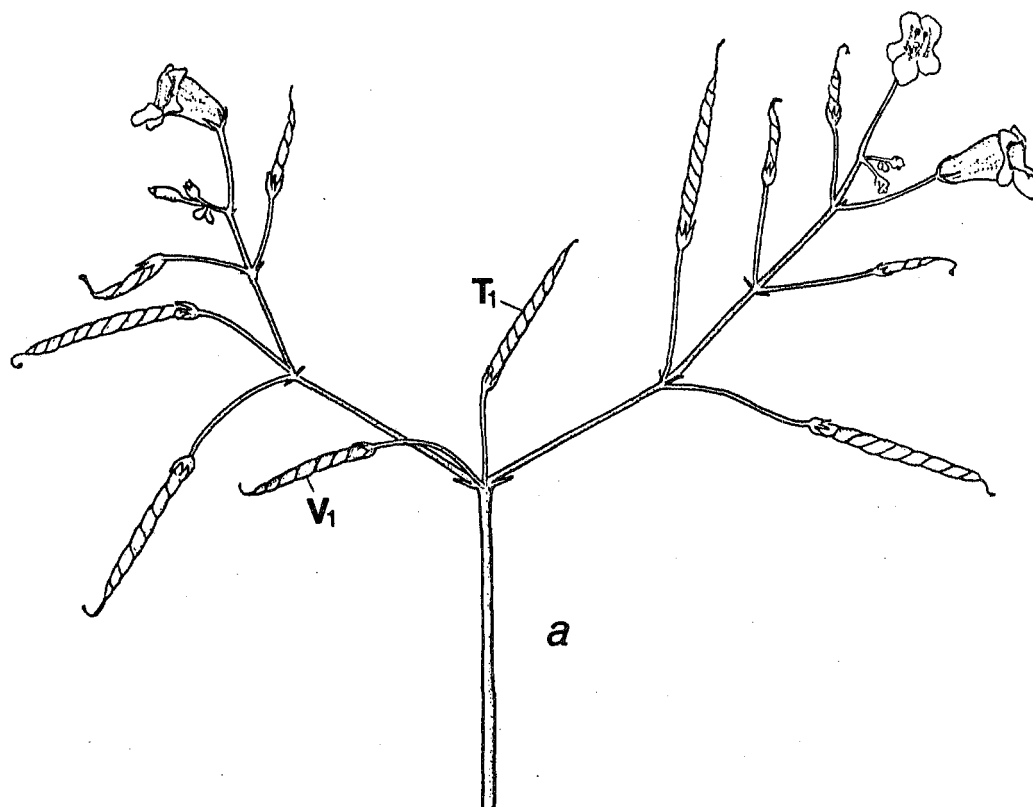

Fig. 1. a Pair-flowered cyme of *Streptocarpus thompsonii*,
 b diagram of a pair-flowered cyme. T terminal flower
 of a cyme unit, V front-flower (from German "Vorblüte")

Hypothesis 1) The front-flowers are serial flowers ("Vorderblüten"). This view has been held by Schumann (1890), Goebel (1931) and Troll (1964). It implies that the front-flowers belong to the same bract as the respective cyme units, but are congenitally "fused" (displaced) to the latter up to the level of the lateral bracts. The gesneriaceous cyme is thus regarded fundamentally as an ordinary cyme, the front-flowers being more or less accidental additions, which in principle do not touch the core of the cyme construction. Indeed Troll, who of the authors cited had the greatest knowledge of the family, does not stress the pair-flowered condition as a constant and essential feature of the inflorescence in Gesneriaceae.

Hypothesis 2) The front-flowers originate through a bifurcation or "serial splitting" of the apex of each cyme unit.

Hypothesis 3) The front-flowers are *de novo* (adventitious) structures, the origin of which is not referable to the common rules of branching and plant construction in angiosperms¹.

All these hypotheses start from the preconception that the pair-flowered cyme is a derivative of the conventional cyme, coming about by a secondary increase in flower number, and they are essentially based on the observation that there is no distinct bract subtending the front-flowers.

This observation, however, is not conclusive and is incomplete. In a previous paper (Weber 1973) it has been established that there are several gesneriads with cymes in which the front-flowers are subtended by distinct bracts. Recent ontogenetical studies in *Sinningia macrorrhiza* show irrefutably, that the front-flower is not merely accidentally associated with this bract, but is indeed its axillary product (fig. 2e, f). Thus the front-flowers must be understood as ordinary axillary and constituent branches within the gesneriaceous cyme. Consequently, the latter must be regarded as a more complex branching system than the conventional cyme. The usual bractless condition is only a secondary feature, resulting from the suppression of the bract development.

1

In regard to the pair-flowered cyme of *Calceolaria* (Scrophulariaceae), Molau (1978) has proposed a further interpretation, in which the terminal flower of each cyme is thought to be abortive and the two flowers are axillary flowers in median-opposite position, the bracts of both being aborted. This interpretation is based on inaccurate observation and has been recently withdrawn by Anderssen & Molau (1980).

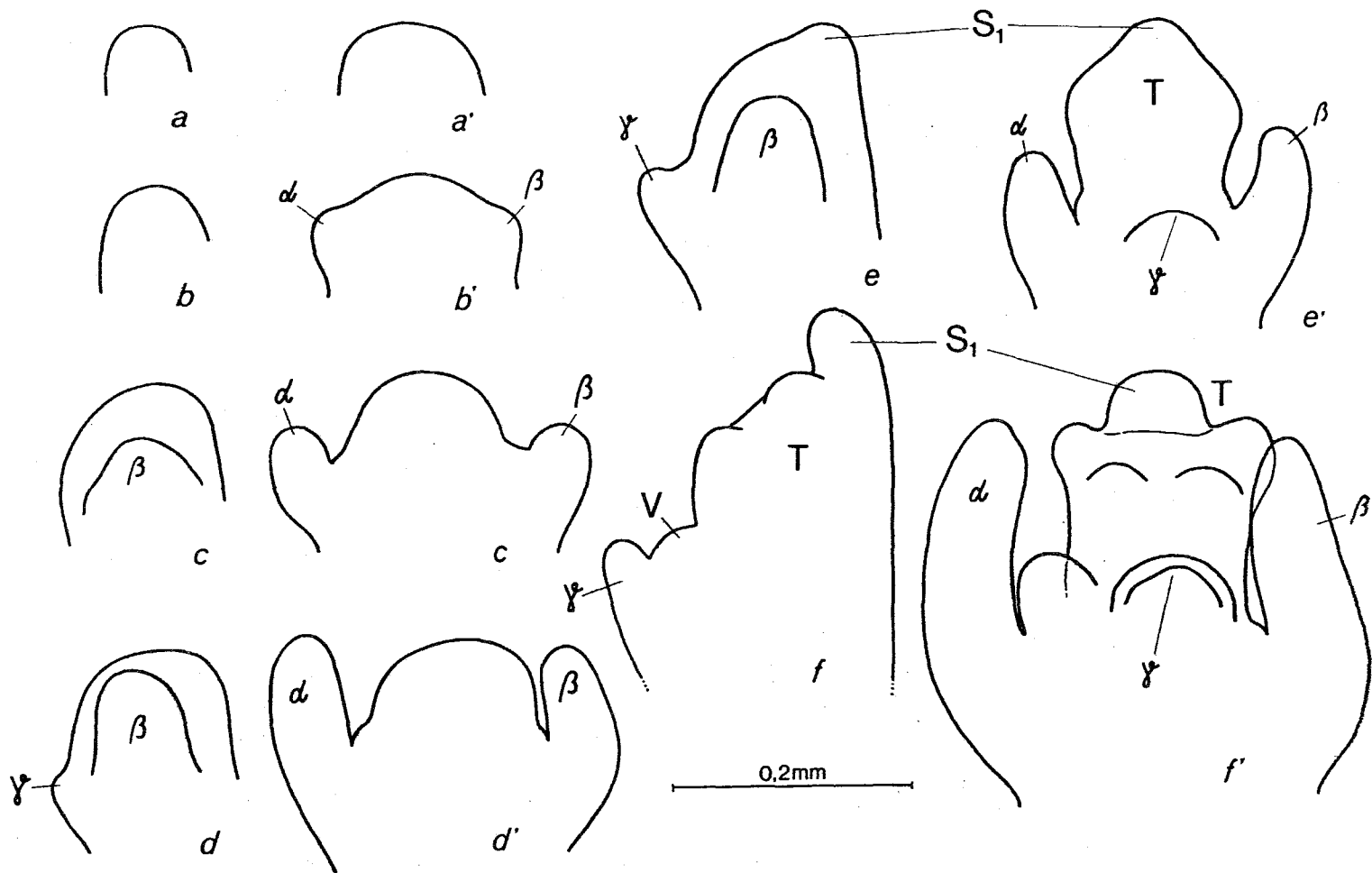

Fig. 2. *Sinningia macrorrhiza*, development of a cyme unit; units shown in side and front view (drawn from cleared whole mounts prepared with the technique of Ritterbusch 1974). α , β lateral bracts (prophylls), T terminal flower of cyme unit, V front-flower, S_1 first (= dorsal) sepal of T .

These findings falsify unequivocally the hypotheses cited above, for which, in addition, no support is furnished by ontogeny (see below).

Thus the following alternatives remain:

Hypothesis 4) The pair-flowered cyme has originated from the ordinary cyme by the adventitious instalment of an axillary flower above the lateral bracts through developing a second node in each cyme unit. In principle, this interpretation is hardly more than a description of the special condition and does not differ much from hypothesis 3. Though it is not clearly disproved so far (the problem is, in fact, how to prove or disprove it empirically!), it appears less probable than the final hypothesis, which has been already outlined in Weber (1973).

Hypothesis 5) The pair-flowered cyme has not originated from a conventional cyme, but from a more complex, panicle-like branching system. This system has successively lost its upper branches, with the exception of one, which became reduced to a single flower, the front-flower. The front-flowers are, therefore, residual flowers.

In this theory the pair-flowered cyme appears morphologically located within a reduction series between a paniculate system and the conventional cyme, the latter, therefore, representing a more derived (reduced) condition than the pair-flowered cyme.

The following facts can be quoted in favour of this hypothesis:

- a) The front-flowers sometimes produce lateral bracts and axillary flowers in them; in other words, the front-flowers can be replaced by branched systems (Irmscher 1959, Weber 1973). The inherent ability for branching substantiates the idea that the front-flowers are remnants of branches.
- b) There exists a small number of gesneriads, in which transitions from pair-flowered to ordinary cymes can be observed, resulting from a progressive suppression of the front-flowers (Weber 1978b, see also below). Such examples illustrate that ordinary cymes may evolve from the more complex branching systems. Of course, this does not infer that ordinary cymes have generally (e.g. in Scrophulariaceae) originated from pair-flowered ones.
- c) As was mentioned already, a few genera in the Scrophulariaceae have pair-flowered cymes. When other characters are considered these genera are not closely allied to Gesneriaceae. Moreover, they do not seem to be closely related to each other, as they are placed in different tribes of Scrophulariaceae.

Thus it could well be that the pair-flowered cyme has originated in Gesneriaceae and in different genera of Scrophulariaceae independently. It is certainly easier to understand such a convergence as a 'stop' at the same morphological condition in a reduction process (panicle → ordinary cyme → single flower) than a parallel achievement of an identical condition by the accidental occurrence and fixation of adventitious structures.

However, there is one fact which seems to contradict the present hypothesis, that is the anthesis sequence of the front- and lateral flowers in the pair-flowered cyme: In a cyme unit the front-flower opens constantly earlier than the lateral flowers and thus indicate a basipetal sequence of flower development. In a system derived from a panicle, one should, however, expect a reverse sequence.

To clarify this problem, the early cyme development of several taxa has been investigated. *Sinningia macrorhiza* provides the most conclusive results, as in that species all flowers of the cyme are associated with bracts (Weber 1973, fig. 8, 9, "*Reichsteineria macrorhiza*"). In each cyme unit the lateral bracts are detached first (fig. 2b, c), then the median bract (= bract of the front-flower) grows out (fig. 2d). The bracts, therefore, appear in strict acropetal order, so do their axillary meristems: At the stage when the median bract occurs (fig. 2d), the meristems of the lateral flowers become visible in the form of slight bulges (fig. 2d). Shortly, but distinctly after that, the primordium of the front-flower is formed in the axil of the median bract (fig. 2e, f). The axillary products of the lateral bracts remain for a considerable time in an initial stage, whereas the primordium of the front-flower grows continuously and soon gets ahead of the lateral structures. Through the faster development and differentiation it ultimately opens earlier than the lateral flowers, which, moreover, have themselves to produce a front-flower and consecutive cyme units.

In conclusion, the sequence of flower opening does not reflect the sequence of flower initiation. The latter is acropetal and thus conforms to the idea that the pair-flowered cyme has originated from a panicle-like inflorescence.

RADIATION OF THE PAIR-FLOWERED CYME

As can be concluded from the wide range of terms which have been used for characterizing the inflorescences of Gesneriaceae, the pair-flowered cyme is a considerably flexible and plastic element. In the following the most important variations regarding structure and position are outlined.

Variations relating to the proportions of the podia

Principally, each cyme unit comprises three internodes (podia): the hypopodium (base to prophyll node), an intermediary podium¹ (prophyll node to node of front-flower), and epipodium (= pedicel). The intermediary podium is nearly always indistinct and, therefore, is disregarded in the following considerations. Usually, in a cyme unit all corresponding podia are of more or less equal length. An exception makes the hypopodium of the primary cyme unit ("peduncle"), the dimension of which is not correlated to that of the subsequent hypopodia.

Based on a simple pair-flowered dichasium, a range of forms arising from the variable extension of the individual podia is represented in fig. 3. For reference, one example is quoted for each: a) All podia contracted ("cluster", "glomerule", "fascicle"; *Dalbergaria sanguinea*). b) Peduncle elongated, other podia contracted ("stalked glomerule", rare; *Streptocarpus glabrifolius*). c) All podia developed, the peduncle being the longest (typical pair-flowered cyme, *Chirita sinensis*). d) Like c, but hypopodia contracted ("stalked umbel"; *Haberlea rhodopensis*). e) Peduncle and following hypopodia contracted, pedicels developed ("sessile umbel"; *Agalmyla parasitica*). f) Like e, but pedicels much elongated and thus compensating the reduced peduncle (*Sinningia speciosa*).

Pendent inflorescences deserve special mention. They belong to type c or d and are characterized by an extensive elongation of the more or less flexible peduncle (except the peduncle being rather stiff and only curved down as in *Cyrtandra pendula*). It is noteworthy that drooping inflorescences are not strongly specific to a certain group of pollinators: They occur (as to be expected) in bat-pollinated gesneriads (*Gesneria pedunculosa*), but also in bird- (*Drymonia pendula*) and insect-pollinated species (*Didymocarpus sulphureus*, *D. robustus*).

Variations relating to flower number

The flower number in a cyme depends on a) the branching pattern, b) the number of successive repetitions of cyme units, and c) the development of serial branches within the cyme.

¹

The term "mesopodium" is not applicable here, as it traditionally refers to a condition in which the prophylls are not opposite, but include a more or less developed internode.

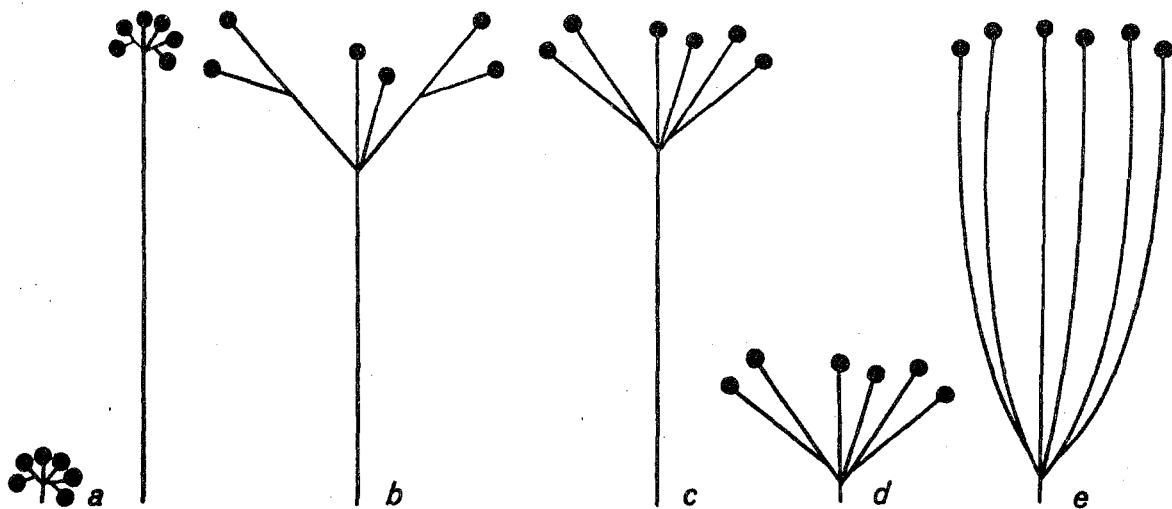

Fig. 3. Various forms of pair-flowered cymes resulting from the variable extension of the constituent podia. Details see text.

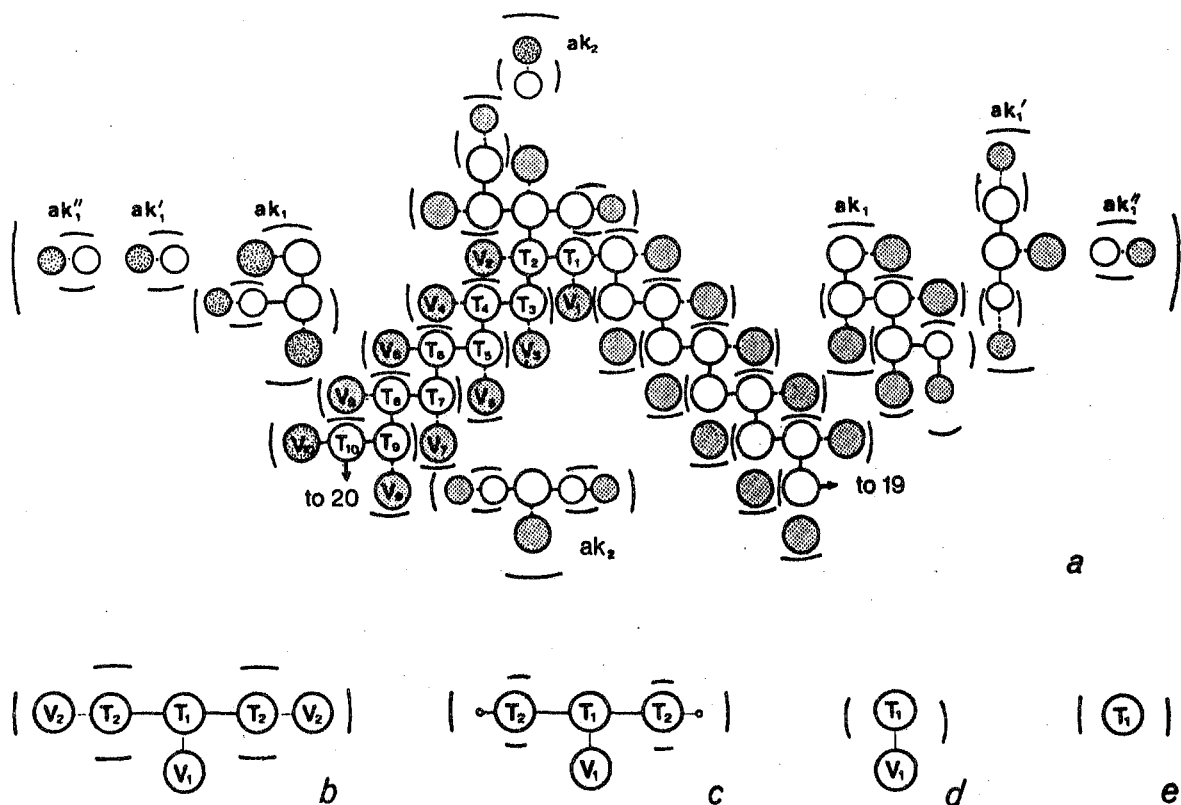

Fig. 4. Diagrams of pair-flowered cymes. a complex form (*Streptocarpus grandis*), ak accessory (serial) branches, front-flowers dotted; b - e reduction series from a six-flowered cyme to a solitary flower.

Many-flowered cymes

In the many-flowered cymes the branching pattern may be a compound (pair-flowered) dichasium (e.g. *Sinningia macrorrhiza*, Weber 1973: diagram fig. 9), a bilateral (common pattern, fig. 1) or a unilateral (scorpioid) cyme (e.g. *Monophyllaea horsfieldii*, Weber 1975: fig. 2a, b). Highly complex cymes are found in some unifoliate species of *Streptocarpus* (fig. 4a) or, still further enhanced, in *Rhynchochotium latifolium* (Clarke 1874: tab. 93); in both, serial branches play an important role.

In connection with the production of numerous cyme units in a rapid succession, some gesneriads (*Monophyllaea*, *Epithema*) have proceeded to a "pseudomonopodial" pattern of cyme development. The cyme units do not emerge one from the other at marked intervals, but seem to be detached from a large, continuously growing meristematic shoot apex. This pattern can be understood as resulting from ontogenetic abbreviation. Each cyme unit has already produced its subsequent unit, at a time when it is itself not more than an undifferentiated meristematic mass. Thus the formation of a new cyme unit anticipates the moulding and differentiation of the mother unit and the youngest units form a confluent mass at the inflorescence apex (for some SEM-illustrations see Hesse and Weber 1981, in which a new deep freeze technique has been employed for ontogenetical studies). In conclusion, the inflorescence development of *Monophyllaea* (and *Epithema*) is a remarkable parallel to that in many Boraginaceae and Solanaceae, in which, however, single-flowered units are produced (for a recent treatment see Huber 1980).

Another interesting feature of the many-flowered cyme in Gesneriaceae is the timing of flower production and flower presentation. There are apparently different "strategies" in operation. In the inflorescence of *Epithema saxatile*, for instance, the flowers are congested to capitule-like structures, and thus appear well disposed for forming more or less showy heads. However, there is only one (or in a short phase of overlapping, two) flower(s) open at a time (fig. 5a). The rather poor attraction effect (which may be even dispensable, as the flowers can produce seeds from self-pollination) is, however, contrasted and compensated by the long time of continuous flower production and presentation. Each inflorescence flowers practically throughout the lifetime of this monocarpic plant. In contrast, in *Agalmyla tuberculata* (fig. 5b) the flowers open more or less synchronously and constitute a showy bunch, which is apparently operative for long-distance attraction of bird pollinators. The same holds true for many species of *Aeschynanthus*, which have "terminal inflorescences" being composed of two or several pair-flowered cymes.



Fig. 5. a Inflorescence of *Epithema carnosum* (from Weber 1976),
 b pair-flowered cyme of *Agalmyla tuberculata*,
 c inflorescence branch of *Drymonia coccinea*,
 d explanatory diagram to c. For explanations see text.

Reduction of flower number

Principally, a decrease of flower number can be achieved by two ways: a) numerical reduction of cyme units, and b) reduction of the front-flowers within the cyme.

- a) This is the common pattern and follows a similar reduction pattern to that which is represented in fig. 4b - e, starting from a six flowered cyme. In many species the full range of reduction stages can be present in one individual plant, in others, the structure and flower number of the cymes are strictly fixed. Four-flowered cymes (usually with rudiments of front-flowers in the lateral units, fig. 4c) are frequent in neotropical Gesneriaceae (Wiehler, in press). Inflorescences which consist of the primary cyme unit only (fig. 4d) are typical for several species of *Chirita* (see below). The last step is the reduction to the terminal flower of the primary unit and thus to a single flower. In this way, the whole system of originally pair-flowered cymes (thyrses) is converted to a raceme. Therefore, the customary distinction of cymose and racemose inflorescences in Gesneriaceae is morphologically impracticable, as it refers to different levels of homology, the partial florescence (sensu Troll), respectively.
- b) The reduction of the front-flowers within the cyme is very rare, but of great theoretical interest. An instructive case has been found in *Chrysothemis friedrichsthaliana*, in which virtually all conceivable reduction stages from pair-flowered to conventional cymes and further to solitary flowers can be observed (for details and diagrams see Weber 1978b). Among a few other taxa, *Chrysothemis* demonstrates conclusively that ordinary cymes may evolve from pair-flowered ones and supports well the idea that the normal cyme does represent a more derived condition than the pair-flowered one.

In the genera *Loxonia* and *Stauranthera*, individual species produce exclusively ordinary cymes in their complex inflorescences. In view of the clear situation in *Chrysothemis*, and, in addition, in view of the undeniable fact that these genera are morphologically and phylogenetically most advanced (Weber 1977), there is little doubt that this condition is secondary.

Variations relating to the bracts

The presence, appearance or absence of bracts within the cyme may be of ecological significance, as well as being an important diagnostic feature. Normally, the lateral bracts are the only ones to develop. These bracts are small, green and scale-like.

In a number of species, even throughout whole tribes (Klugieae incl. Loxonieae, Beslerieae), they are completely abortive. In contrast, the bracts may be considerably enlarged and vividly coloured, frequently in connection with bird pollination. In such cases, the bracts (and sepals) are commonly red, while the corolla is yellow (e.g. *Corytoplectus vittatus*, *Drymonia coccinea*).

Connation of the bracts is not uncommon and is most conspicuous and widespread in the genus *Cyrtandra*. The bracts of the primary cyme unit often form a large, cup- or cupule-like structure which, in addition, may be variously coloured. Before flowering, such a cup may be completely closed and filled with a slimy liquid, in which the flower buds develop (a kind of extra-floral "water-calyx"). The bright white bract cupules of some *Cyrtandras* (*C. burbridgei*, *C. leucochlamys*) are most striking and may help to attract pollinators (moths?)

A feature which seems to have been totally ignored so far, is the displacement (congenital shifting) of the bracts. Such a displacement may be slight (*Streptocarpus* sp. div.) or may extend over the whole hypopodium (as in *Agalmyla tuberculata*, fig. 5b or, in an even more impressive form, in *Drymonia coccinea*, fig. 5c). In these examples, two bracts of unequal size arise at the base of each flower pair. Neither, however, is the subtending bract of the following cyme unit. Furthermore, these bracts are not placed opposite one another, but rather, are arranged more or less at right angle to each other. The explanation is that these two bracts belong to different cyme units. The fertile (= large) bract is constantly displaced ("fused") to its axillary cyme unit, whereas the sterile (small) bract remains at its proper place (cf. diagram fig. 5d). Apart from the fact that the cyme units comprise two flowers, the inflorescences of *Drymonia coccinea* match entirely with the well-known anthocladia of Solaneae (e.g. *Atropa belladonna*).

*Variations relating to the position*¹

As is implicit in the classification of the inflorescence of Gesneriaceae as a polytelic system, the partial florescences = pair-flowered cymes must occur in a lateral (axillary) position. The axillary origin is evident in most cases, but there are a few exceptions, in which it is masked.

¹

No reference is made here to the genera *Streptocarpus* and *Monophyllaea*, as the morphological situation is in some species extremely complicated. This must await a special treatment.

Epiphyllly

An example of progressive displacement of the subtending bract of the cyme (as in *Thesium*, cf. Troll 1964: 128) has been established in *Sinningia aggregata*. In the lower part of the flowering region (here identical with the main florescence) the (usually 4-flowered) cymes emerge strictly from the axils of foliage leaves. Higher up the subtending leaves become reduced in size and progressively displaced up the peduncle of the cyme. In the uppermost part the (very small) bract appears inserted just at the base of the front-flower and can be easily mistaken for its proper bract (which is, however, abortive).

The bract displacement has become fully established in *Loxsonia hirsuta* and in most species of *Rhynchochoglossum*, in which the tiny bracts are shortly displaced relative to their axillary structures (ordinary cymes and single flowers, respectively) throughout the inflorescence (Weber 1977, 1978a).

A comparatively complex condition is found in several species of *Chirita* sect. *Microchirita*. On the petiole of each leaf there arises a fan of paired flowers, all arranged in one plane. This peculiar inflorescence has been differently interpreted. According to Weber (1975a) it is a system of pair-flowered cymes which are uniformly reduced to the primary unit and thus to a flower pair. The high number of pairs is achieved by serial shoot formation. The whole system is shifted to the petiole, particularly prominent in *Chirita micromusa* (fig. 6a). Nevertheless, the axillary origin remains obvious in that a kind of concrescence of the peduncle of the first flower pair and the petiole is visible (fig. 6a). Ontogenetically, this first pair is indeed initiated in a strictly axillary position, the primordial bulge being even more associated with the shoot apex than to the base of the subtending leaf (fig. 6b-d). The moving out from the leaf axil is an ontogenetically rather late event and is caused by an extension of the common bases of the leaf and its axillary structure (Weber, under prep., see also Boldt 1897).

Pseudoterminal position

In the literature, Gesneriaceae are said to have axillary as well as terminal inflorescence. As in the distinction of cymose and racemose inflorescences (see above), this view results from mixing up partial florescences and florescences. As to the florescence, the terminal position is in agreement with the classification as a polytelic system. This implies, however, that the partial florescence = pair-flowered cymes must not occur in a terminal position. The question arises whether this is consistent with empirical facts.

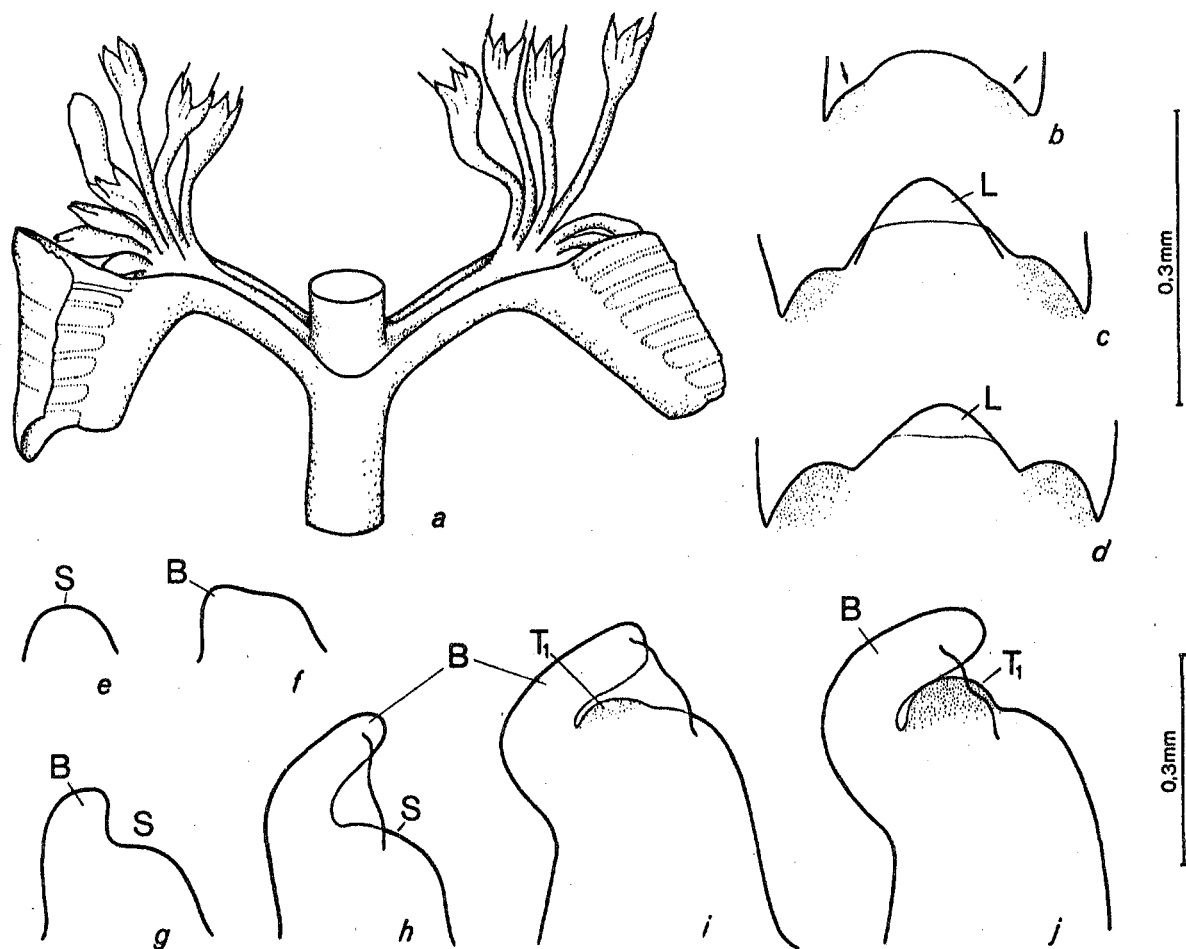

Fig. 6. a-d *Chirita micromusa*,
 a leaf pair with epipetiolar inflorescences,
 b-d shoot apex with developing axillary inflorescences (stippled),
 L uppermost (youngest) leaf (pair).
 e-j *Epithema saxatile*, early stages of inflorescence development;
 S shoot apex (inflorescence apex), B embracing bract, T_1
 primordium of first flower (stippled).
 b-j drawn from cleared whole mounts (cf. fig. 2). For explanations
 see text.

There is indeed one case, which has recently caused confusion: *Epithema*. In this genus the individual inflorescences appear as stalked, much condensed pair-flowered cymes, which are embraced by a cucullate bract. They occur in axillary and in terminal positions. When terminal, the stalk is the uppermost internode of the main axis. In Weber (1976), the interpretation has been offered that these inflorescences are not simply homologous to partial florescences, but represent much reduced florescences, comprising one florescence internode (= stalk), one bract at its top and the axillary cyme of the latter. As there is no distinct apical rudiment of the florescence axis present, the first flower of the cyme appears terminally. This concept has been recently called in question by Huber (1980). Disregarding arguments from comparative morphology, he suggested an alternative, in his opinion less theory-bound interpretation, in which the "terminal" flower is regarded as truly terminal.

Subsequently, material of *Epithema saxatile* (from South East Asia) has been collected and cultivated so that ontogenetical investigations could be carried out. These investigations clearly show that the original concept is correct. As is apparent from figs. 6e-j, the actual apex of the prospective "stalk" is not transformed into a flower, but first detaches a bract on one side (fig. 6f, g). Intimately adjacent to the insertion of this bract, - and not exactly in the centre of the apex!, the primordium of the first flower emerges as a distinct, meristematic dome (fig. 6i, j). Its separate initiation, and its association with the bract, leaves no doubt that it is lateral (*sub* terminal) in origin. The shoot apex does not grow up into a distinct tip, which could be clearly recognized as the rudimentary florescence apex. In Troll's terminology (1964) the term "pseudoterminal" as used above has to be replaced by "subterminal", as the lateral origin of the "terminal" flower is evident in ontogeny.

CONCLUDING REMARKS

The aim of the present paper was twofold. First, to show that the pair-flowered cyme is the basic constituent of the inflorescence architecture of Gesneriaceae and that it is probably not derived from a conventional cyme by the installment of additional flowers. More likely, it represents an intermediate form between an ancestral paniculate system and the conventional cyme, the front-flowers being residual flowers.

This interpretation is most relevant in regard to the assessment of the phylogenetic position of Gesneriaceae, in particular in comparison with the closely related Scrophulariaceae. Both have probably evolved from a common ancestor with a more or less variable, panicle-like branching pattern of the inflorescences. The axillary panicles then became reduced and switched to a cymose branching mode.

By still having residual flowers (which became strongly fixed and integrated in the cyme), Gesneriaceae appear to have maintained a comparatively primitive condition throughout the family and thus seem to occupy a less advanced position than Scrophulariaceae in regard to the inflorescence organisation. By more intense reduction, Scrophulariaceae proceeded mostly to ordinary cymes, and further - by reduction of these to the primary unit - to solitary flowers, which together constitute racemose inflorescences. This idea agrees well with the fact that the most advanced Scrophulariaceae, that is the hemi- and holoparasitic ones, have constantly racemose inflorescences.

The second aim of the present (naturally very sketchy) survey was to demonstrate that the pair-flowered cyme shows a considerable amount of variation and plasticity. Knowledge of the amount of variation and a precise understanding of the individual forms should help to replace mere descriptive terms and lead to a more adequate definition and classification of the respective taxa. Moreover, a precise morphological understanding of the variations is the prerequisite for the recognition of progressive developments and thus for the reconstruction of phylogeny.

In the pair-flowered cyme, such progressions certainly include:

- a) The excessive increase of flower number by a high elaboration of the cyme, or, on the other hand, the reduction of the cyme to two- or one-flowered units.
- b) The transition from a cymose to a monopodium-like developmental pattern by ontogenetic abbreviation.
- c) The reduction of the front-flowers within the cyme, by which the pair-flowered cyme is transformed into a conventional one.
- d) The abortion of the bracts, or, in contrast, their enlargement, coloration and/or connation in relation to special functions.
- e) The displacement of the bracts within the cyme, and
- f) the masking of the axillary origin by congenital fusion and displacement of the cyme.

Especially noteworthy are the parallels of the inflorescence construction and development to other families of "Tubiflorae", in particular to Solanaceae and Boraginaceae.

Acknowledgments

Many observations and studies referred to in the present paper were made possible through a collecting trip to Malaya and Borneo in 1979, which was sponsored by the Austrian "Fonds zur Förderung der wissenschaftlichen Forschung" (project 3949). The support is gratefully acknowledged. Special thanks I owe to Miss Mag. S. Kollar, who prepared the illustrations. To Mr B.L. Burtt (Edinburgh) I am indebted for critical reading of the manuscript.

References

- ANDERSSON, L. & MOLAU, U., 1980. The inflorescence of *Calceolaria*. Bot. Notiser 133: 21-32.
- BOLDT, C.E., 1897. Om epiphylla blömmor hos *Chirita hamosa* R.Br. Videnskab. Meddel. Kjøbenhavn 1897: 332-355.
- BURTT, B.L., 1970. Studies in the Gesneriaceae of the Old World. XXXI. Some aspects of functional evolution. Not. Roy. Bot. Gard. Edinb. 30: 1-10.
- CLARKE, C.B., 1974. Commelynaceae et Cyrtandraceae Bengalenses. Calcutta.
1883. Cyrtandreae. In De Candolle, A. et C. Monographiae Phanerogamarum 5/1, Paris.
- FRITSCH, K., 1893. Gesneriaceae. In Engler, A., Prantl, K. Die natürlichen Pflanzenfamilien IV/3b, Leipzig.
- GOEBEL, K., 1931. Blütenbildung und Sprossgestaltung (Anthokladien und Infloreszenzen). Jena
- HESSE, M., & WEBER, A. 1981. Blütenontogenetische Untersuchungen an *Monophyllaea horsfieldii* mit Hilfe eines neuen Tieftemperatur-Präparationsverfahrens. Beitr. elektronenmikroskop. Direktabb. Oberfl. 14: 625-630.
- IRMSCHER, E. 1959. Über Blüten- und Blütenstandsvarianten bei *Saintpaulia ionantha* Wendl. (Gesneriac.) und die morphologische Valenz der Vorblüten. Flora 148: 179-202.
- HUBER, K. 1980. Morphologische und entwicklungsgeschichtliche Untersuchungen an Blüten und Blütenständen von Solanaceen und *Nolana paradoxa* Lindl. (Nolanaceae). Diss. botanicae 55.

- MOLAU, U. 1978. The genus *Calceolaria* in NW South America.
I. Taxonomic characters and generic subdivision.
Fasciculata, a new section. Bot. Notiser 131: 219-227.
- RITTERBUSCH, A. 1974. Die Herstellung von Totalpräparaten von
Blüten für entwicklungsgeschichtliche Untersuchungen.
Mikroskopie 30: 224-228.
- SCHUMANN, K. 1980. Neue Untersuchungen über den Blütenanschluss.
Leipzig.
- TROLL, W. 1964. Die Infloreszenzen. Typologie und Stellung im
Aufbau des Vegetationskörpers. Bd. 1. - Jena.
- WEBER, A. 1973. Die Struktur der paarblütigen Partialfloreszenzen
der Gesneriaceen und bestimmter Scrophulariaceen.
Beitr. Biol. Pflanzen 49: 429-460.
- 1975a: The cristate inflorescence of *Chirita* sect. *Microchirita*
(Gesneriaceae). Not. Roy. Bot. Gard. Edinb. 34: 221-230.
- 1975b: Beiträge zur Morphologie und Systematik der Klugieae
und Loxonieae. I. Die Spross- und Infloreszenzorganisation
von *Monophyllaea*. Bot. Jahrb. Syst. 95: 174-207.
- 1976: Id. IV. Wuchsform, Infloreszenz- und Blütenmorphologie
von *Epithema*. Plant Syst. Evol. 126: 287-322.
- 1977: Id. VI. Morphologie und Verwandtschaftsbeziehungen von
Loxonia und *Stauranthera*. Flora 166: 153-175.
- 1978a: Id. VII. Spross- Infloreszenz- und Blütenbau von
Rhynchoglossum. Bot. Jahrb. 99: 1-47.
- 1978b: Transitions from pair-flowered to normal cymes in
Gesneriaceae. Not. Roy. Bot. Gard. Edinb. 36: 355-368.
- WIEHLER, H. (in press) Generic delimitation in a new classification
of the neotropical Gesneriaceae. Selbyana.



SYSTEMATICS OF ARALIACEAE AND INFLORESCENCE MORPHOLOGY*

D.G. Frodin

Department of Biology, University of Papua New Guinea
P.O. Box 4820, Papua New Guinea.

Classification within the Araliaceae in the traditional narrow sense, as accepted by most authors up to and including Hutchinson (1967) and Dahlgren (1980) but not Thorne (1973), has generally been marked by the successive proposition of variously monothetic to polythetic arrangements of genera from Seemann (1864-68) through Harms (1894-97) and Viguier (1906) to Hutchinson (1967). As reviewed by Frodin (1970) and Eyde and Tseng (1971), these have usually involved differing manipulation of a relatively small number of what are, in retrospect morphologically comparatively labile floral and fruit attributes (Table 1). With perhaps one exception, the system of Harms (1894-97), none of these arrangements has gained any lasting acceptance.

The period since 1945 has seen much new research on the family, involving a wide variety of approaches. Gross structural, morphological, anatomical, palynological, biochemical, and general-systematic lines of enquiry have all been followed, either specifically relating to the family or in conjunction with comparative studies covering a number of families (e.g. Philipson, 1974, 1977). A review of much of this work has been made by Professor Philipson and the present writer in the introduction to the *Flora Malesiana* treatment of Araliaceae (Philipson 1979), but it has been judged premature to advance a new system. The first real departure from the traditionally strong emphasis upon reproductive features in generic classification was taken by Eyde and Tseng (1971) who, while not proposing a new system in a formal sense, stressed the fundamental importance of the distinction in leaf-structure between pinnately compound arrangements versus digitately compound or lobed arrangements (Eyde & Tseng, 1971, fig. 9). Eyde and Tseng also presented evidence suggesting that the presence of moderate pleiomery of units [10-15] in the gynoeceium may be representative of the ancestral state in the family, rather than the pentamerous state usually accepted. Other contributions to a knowledge of possible phylogenetic trends in the "narrow" Araliaceae include the demonstration of a reversion to hypogyny in *Tetraplasandra gymnocarpa* from Hawaii

* This paper was originally read at the XIII International Botanical Congress, Sydney, Australia, 26 August 1981.

TABLE 1

Floral and other attributes traditionally used for generic classification in the Araliaceae.

1. Leaves: pinnately compound, digitately compound, digitately lobed, or simple
2. Pedicels: articulated or not articulated
3. Petals: valvate, imbricate or clawed at base (the last named resembling the situation in Umbelliferae)
4. Petals: degree of fusion (not fused, partially fused, or wholly fused into a cap)
5. Stamens: less than 5, 5, between 5 and 15, more than 15
6. Stamens: insomalous or not insomalous (if not insomalous then usually greater than the number of carpels)
7. Styles: absent or present; if present then with varying degrees of fusion from free to united
8. Ovary: number of locules (= carpels) 1, 2, 5 (more or less), 10 (more or less), 15-20, more than 20
9. Albumen: ruminant or not ruminant
10. Inflorescence (terminal parts): flowers in umbellules, capitula, racemules or spicules; branch arrangement paniculate or umbellate
11. Sex: hermaphroditic, polygamo-dioecious or dioecious
12. Floral whorls: numerical relation between any two (or more) whorls in respect to number of parts (including #6 above)

by Eyde and Tseng (1969), the problem of bundle-compound leaves in *Schefflera* by Grushvitzky and Skvortsova (1970), analysis of pollen types by Tseng and others in Araliaceae and related Umbelliferae (most recently in Tseng and Shoup, 1978), and considerations of various structural, morphological and anatomical features by Philipson (1970, 1978, 1979).

Preliminary studies by Grushvitzky and Skvortsova (1966), and later by Philipson (1970), and Frodin (1970, 1975), suggest that the inflorescence as a whole can also be potentially a very useful tool in generic and infrageneric classification in the Araliaceae. It has also been used as part of evidence demonstrating the necessity of excluding *Aralidium* from the family (Philipson et al., 1980). Yet low weighting has usually been its lot, despite the apparently great importance attached by some past writers, such as Hutchinson (1967), to its ultimate portions with their differing floral arrangements (e.g. racemosely arranged capitula, umbellules, racemules, or spicules, or compound umbels bearing umbellules). This situation has, I believe, largely come about on account of the great bulk of whole inflorescences in many species (they can attain several metres in length and breadth and weigh 20 kilogrammes or more) and their consequent imperfect representation in herbaria, although hallowed Gandolleian tradition has most likely also contributed. Rectification of this lacuna has required, and will require, more study in field and botanic garden.

A change in methodological approach is also needed. In many quarters, including in general the anglophone botanical world, perception of the inflorescence appears to have been almost purely empirical-descriptive (Rickett 1944, 1955; Philipson 1970). Even an otherwise well-written and organised recent textbook of systematics (Stace, 1980) fails to make any reference to alternative approaches, while the widely dispersed American texts of Radford et al. (1974) and Jones and Luchsinger (1979) are rooted in the empirical-descriptive tradition. More fruitful has been the use of the typological system developed by Troll and his students (Troll, 1964-69; Froebe, 1971; Weberling, 1965, 1981) which requires rigorous structural and developmental analysis, not only intrinsically but also with reference to floral biology and other factors. This approach, a kind of botanical equivalent to the architectural-linguistic processes of "listing" and "reintegration" (Zevi, 1978), has assisted greatly in developing an effective paradigm for understanding the wide variety of inflorescences in Araliaceae through which useful attributes can be derived and, in turn, possible evolutionary polarities (Stevens, 1980) hypothesized.

The Troll "system" is, however, but a framework: any inflorescence "types" which may be recognized are only *points of reference* or *loci* in a continuous space. Whether or not all possibilities are actually represented among the 1100-odd living araliad species, as was argued long ago by Diels (1932) for the features distinguishing genera in the Annonaceae, is a problem yet to be worked out; but it is certain that some inflorescence "types" are far more widespread in the family than others. Very likely such "types" are those which are biologically successful in a given context of genetic stock and environment. A hypothetical inflorescence is given in Figure 1 and a stylized drawing of a widespread "type" - found, for instance, in *Schefflera versteegii* Harms - in Figure 2.

A listing of potentially useful attributes based upon features of the inflorescence is given in Table 2. It should be stressed that structurally the inflorescences in Araliaceae sensu stricto all appear to be *indefinite*, or, in Troll's sense, they are *polytelic synflorescences*. This situation seems also to prevail in the umbelliferous subfamilies Saniculoideae and Apioideae, but not in the Hydrocotyloideae, where Froebe (1971, 1980) has demonstrated that the inflorescences are fundamentally *monotelic*, with single flowers terminating all axes in, for example, the Australian *Platysace dissecta* F. v. M. [Analysis of this apparent discrepancy within the Umbellales is beyond the scope of this paper but it is noted here in the belief that inflorescence analysis is an exercise of value for the order as a whole (sensu Dahlgren, 1980).]

Apart from the recognition of polytely as being structurally basic in the Araliaceae, other postulates accepted here as a basis for detailed inflorescence analysis are that a) the classical concept of the shoot is valid, as also accepted by Philipson (1978) in his review of growth forms; b) shoot systems in Araliaceae have for most part a sympodial arrangement, with orthotropic articles (Hallé et al. 1978); and c) Umbellales are delimited in a narrower sense and moreover are viewed as showing some links with Vitales and Rurales with, however, a distinction made at supraordinal level (Dahlgren, 1980).

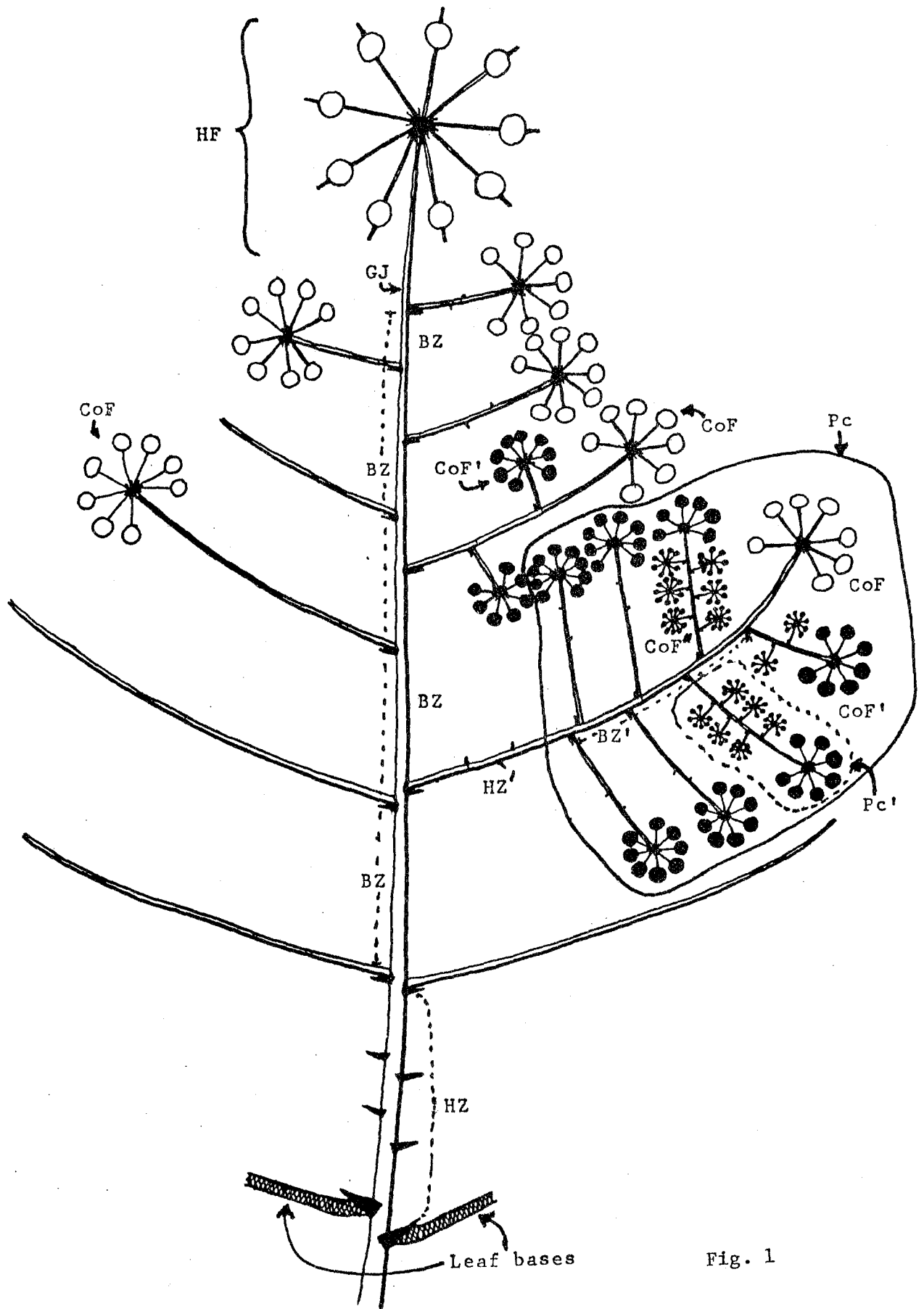

Fig. 1

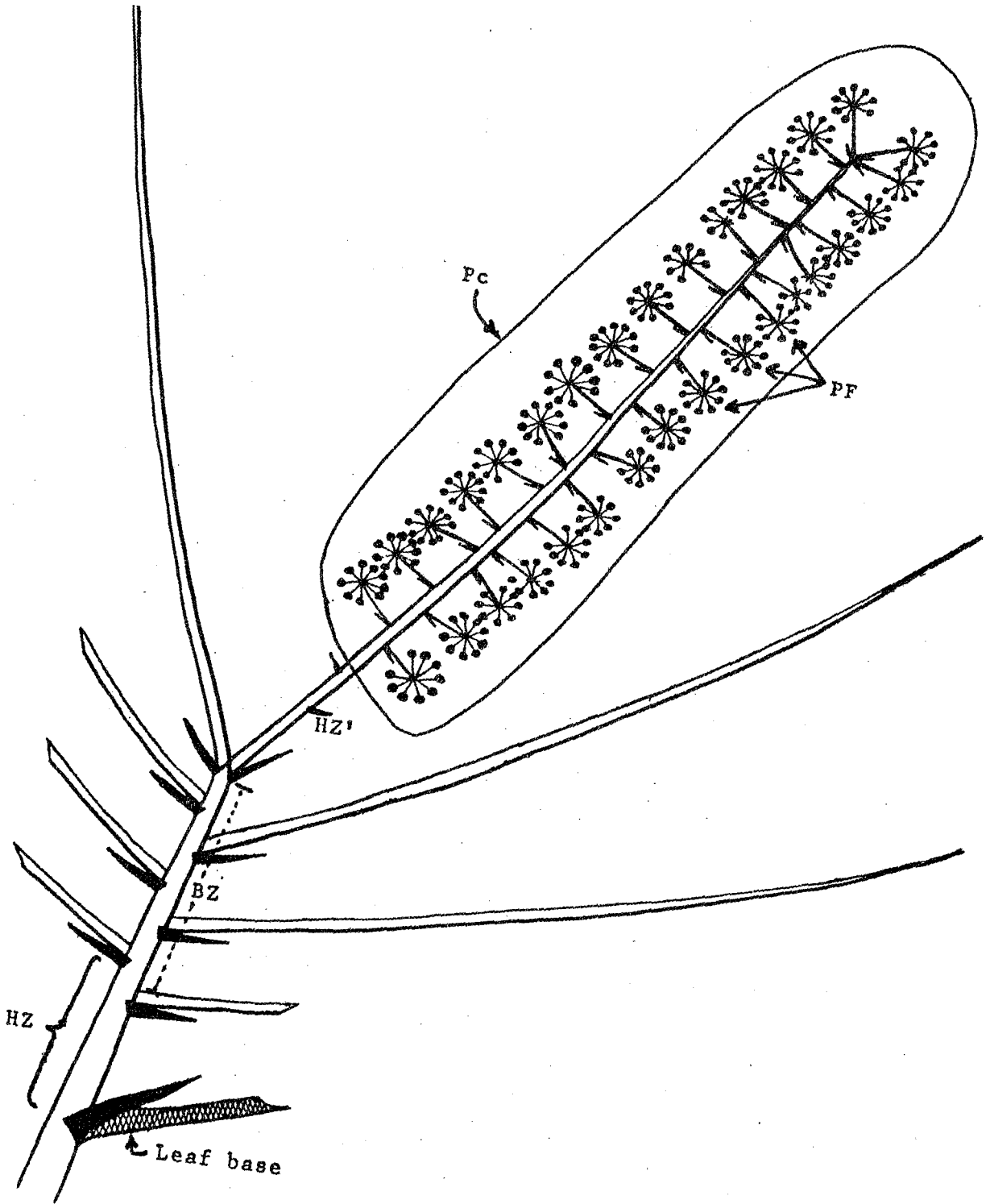

Fig. 2

TABLE 2

Discernable Inflorescence Attributes

1. The "Gestalt" of the inflorescence when fully developed, both in flower and in fruit.
2. Lengths of main axis and all branches, and their relation to one another
3. Disposition of branches (including the paniculate, racemose, and umbellate of earlier writers)
4. Degree of "enrichment", and position of "enriched" portions relative to the whole
5. Arrangement of flowers on ultimate branchlets: umbellulate, capitulate, racemulate, or spiculate
6. Inflorescence as a whole "racemoid" (without upper portion(s) behaving as a terminal unit, analogous to a single terminal flower) or "cymoid" (in which an upper portion, or portions at axial ends, behave as a terminal unit or units as if they were terminal flowers).
7. Inflorescence in relation to associated vegetative parts terminal (above vegetative rosette) or pseudolateral (below vegetative rosette and apparently lateral due to delayed development of terminal floral axis).
8. Number of new vegetative articles succeeding maturing inflorescence (0, 1, more than 1)

Although critical studies have reached but an early stage, it has been possible to discern certain trends relating to inflorescence phylogeny, and these are set out in Table 3. While it is premature to construct a detailed scheme, even one purely qualitative, one overall conclusion seems inescapable: gradual reduction in size and increasingly specialized organisation of inflorescences has been the order of the day. Early araliads, like early rutads (of which such genera as *Hortia*, *Zanthoxylum*, and especially *Spathelia* may be modern representatives; the latter includes *Sohnreyia excelsa* Krause, mentioned by Corner (1964) as being monocarpic and palm-like)¹ and early vitads (of which *Leea* appears to be the nearest living equivalent) were very likely pachycaulous rosette-plants or rosette-trees, with branches absent or but few in number (Mabberley 1979) and with large, heliophilous, terminal inflorescences. The bizarre Malesian genus *Harmsioplanax* and the somewhat more advanced genera *Gastonia*, *Polyscias* and *Schefflera* among Araliaceae strongly retain these characteristics in greater or lesser degree. The inflorescences in the three species of *Harmsioplanax* (Philipson, 1979) in particular contain features which may help to resolve the apparent conflict between monotely in the Hydrocotyloideae and polytely in the rest of the Umbellales; some preliminary studies have been carried out by the present writer and will be reported on in a separate paper. *Sciadodendron*, in Middle America, is also striking, with the habit of a fishtail palm, or *Caryota* (Harms, 1894-97) and large inflorescences. With an increasing amount of branching and concomitant shortening of articles, or (in some general) a move towards sciaphily and reduced stature, there has been a concomitant reduction in size and increasing functional specialization among inflorescences. Among the most striking trends are a shift in inflorescence position from terminal to pseudolateral and structural specialization in the form of compound umbels, as indicated in Table 3; the latter trend forms a parallel with the subfamily Apioideae in the Umbelliferae, where also a number of woody forms exist, notably in some species of *Bupleurum* and in *Heteromorpha*, *Myrrhidendron* and *Steganotaenia* (Rodriguez, 1957, 1971). Of interest is the fact that the three latter genera are predominantly mountain-dwellers of open places like the species of *Harmsioplanax*; in particular, photographs of *Myrrhidendron donnell-smithii* Coult. & Rose made in Costa Rica (Rodriguez, 1957) strongly recall the habit of *Harmsioplanax aculeatus* (Bl.) Warb. ex Boerl. in Java (Philipson, 1979), with both having conspicuous terminal inflorescence. Rodriguez (1957) has also reported on two woody species in the otherwise herbaceous genus *Eryngium* in the Saniculoideae: *E. bupleuroides* Hook. & Arn. and *E. inaccessum* Skottsbo., both endemic to the Juan Fernández Islands west of Chile; the former can reach 2 metres in height. Unfortunately,

¹ *Hortia*, *Zanthoxylum* and *Spathelia* are all covered in Alberquerque, B. W. P. de. 1976. Revisão taxonômica das Rutaceae do Estado do Amazonas. *Acta Amazonica* 6, Suppl.: 1-67, illus. *Spathelia* (Sohnreyia) and *Harmsioplanax* were both labelled as hapaxanthic "rain forest pioneers" by Mabberley (1979, p. 266).

TABLE 3

Possible phylogenetic trends in inflorescences of Araliaceae

1. Inflorescences fundamentally "cymoid" (*Harmsiopanax*) or "racemoid" (*Gastonia*, *Polyscias*, *Schefflera*) with an advance to the "cymoid" state (Part of *Schefflera*, *Oreopanax*, *Seemannaralia*, *Fatsia* or *Hedera*)
2. Rearrangement of inflorescence branches from the paniculate state to the compound-umbellate state (as in most Umbelliferae)
3. Reduction of inflorescence to a single terminal umbellule (*Dendropanax*, *Panax*)
4. Delay in development of inflorescence axis resulting in inflorescence assuming a pseudolateral position beneath vegetative rosette (probably related to pollination and/or dispersal methods together with habitat)
5. From an ancestral condition of many primary branches to fewer such branches, with ultimately only 1
6. Reduction in length of main inflorescence axis, with ultimately almost complete reduction in compound umbellate inflorescences
7. Sexual specialization within inflorescence and incipient pseudanthy
8. Inflorescences pachycaulous (*Harmsiopanax*, some species of *Schefflera*) to leptocaulous (*Kalopanax*, some species of *Schefflera*)

critical studies of the inflorescences of these interesting plants do not appear to be available, but given their overall systematic position, the level of inflorescence specialization is likely to be greater than in comparable Araliaceae.

In conclusion, therefore, it seems clear that the careful study of the inflorescence morphology of the Araliaceae (and, by extension, the woody Umbelliferae) can yield potentially valuable information for classification within the Umbellales and, possibly, for comparative studies of the Umbellales with other orders of flowering plants. The Troll typological system provides a useful framework for inflorescence analysis, but sight should not be lost of morphological "space" nor of the relationships of inflorescences with other plant parts or with their physical and biological environment.

Acknowledgements

Part of the work for this study was carried out during the author's term as a research student in the Botany School, University of Cambridge. Thanks are due to Professor E.J.H. Corner for advice and encouragement at all times during those three years. The Research Committee of the University of Papua New Guinea has provided the means for carrying out field work in that country.

References

- CORNER, E.J.H. 1964. *The life of plants*. London.
- DAHLGREN, R.M.T. 1980. A revised system of classification of the angiosperms. *Bot. J. Linn. Soc.* 80: 91-124.
- DIELS, L. 1932. Die Gliederung der Anonaceen und ihre Phylogenie. *Sitzungsber. Preuss. Akad. Wiss., Phys.-Math. Kl.* (1932): 77-85.
- EYDE, R. & TSENG, C.C. 1969. Flower of *Tetraplasandra gymnocarpa*: hypogyny with epigynous ancestry. *Science* 166: 506-508.
- EYDE, R. & TSENG, C.C. 1971. What is the primitive floral structure of the Araliaceae? *J. Arnold Arbor.* 52: 205-239.
- FRODIN, D.G. 1970. The complex of *Cephaloschefflera* in *Schefflera*. Unpubl. Ph.D. dissertation, Cambridge University.

- FRODIN, D.G. 1975. Studied in *Schefflera*: The Cephaloschefflera complex. J. Arnold. Arbor. 56: 427-448.
- FROEBE, H.A. 1971. Inflorescence structure and evolution in Umbelliferae. In Heywood, W.H., ed. The biology and chemistry of the Umbelliferae (Reading, 1970), pp. 157-176. London.
- RICKETT, H.W. 1944. The classification of inflorescences. Bot. Rev. 10: 187-231.
- RICKETT, H.W. 1955. Materials for a dictionary of botanical terms, III: Inflorescences. Bull. Torrey Bot. Club 82: 419-445.
- RODRIGUEZ, R.L. 1957. Systematic anatomical studies on *Myrrhidendron* and other woody Umbellales. Univ. Calif. Publ. Bot. 29(2): 145-318, pl. 36-47.
- RODRIGUEZ, R.L. 1971. The relationships of the Umbellales. In Heywood, V.H., ed. The biology and chemistry of the Umbelliferae, pp. 63-91. London.
- SEEMANN, B. 1864-68. Revision of the natural order Hederaceae. I-XVII. J. Bot. 2-6, passim. (Repr. in 1 vol., 1868, London).
- STACE, C.A. 1980. Plant taxonomy and biosystematics. London.
- STEVENS, P.F. 1980. Evolutionary polarity of character states. Ann. Rev. Ecol. Syst. 11: 333-358.
- THORNE, R.F. 1973. Inclusion of the Apiaceae (Umbelliferae) in the Araliaceae. Notes Roy. Bot. Gard. Edinburgh 32: 161-165.
- FROEBE, H.A. 1980. Die Infloreszenzen der Hydrocotyloideen (Apiaceae). (Abh. Akad. Wiss. Lit. Mainz, Reihe trop. & subtrop. Pflanzenwelt (ed. W. Rauh), 29) Stuttgart.
- GRUSHVITZKY, I.V. & SKVORTSOVA, N.T. 1966. [Two new species of *Schefflera* Forst. from the Democratic Republic of Vietnam.] Bot. Zhurn. SSSR 51: 1709-1718.
- GRUSHVITZKY, I.V. & SKVORTSOVA, N.T. 1970. [On a new compound leaf-type. The bundle compound leaf in the species of the genus *Schefflera* Forst. f.] Ibid., 55: 525-536.

- HALLE, F. *et al.* 1978. Tropical trees and forests. Berlin.
- HARMS, H. 1894-97. Araliaceae. In Engler & Prantl. eds. Die natürlichen Pflanzenfamilien, 1. Aufl., Teil III, Abt. 8, pp. 1-62. Leipzig.
- HUTCHINSON, J. 1967. Araliaceae. In id. The genera of flowering plants vol. 2, pp. 52-81. Oxford.
- JONES, S.B., Jr., & LUCHSINGER, A.E. 1979. Plant systematics. New York: McGraw-Hill.
- MABBERLEY, D.J. 1979. Pachycaul palms and islands. In Bramwell, D. ed. Plants and islands (Las Palmas, 1977), pp. 259-277. London.
- PHILIPSON, W.R. 1970. Constant and variable features of the Araliaceae. In Robson, N.K.B., et al., eds. New research in plant anatomy (London, 1970) pp. 87-100. London
- PHILIPSON, W.R. 1974. Ovular morphology and the major classification of the dicotyledons. Bot. J. Linn. Soc. 68: 89-108.
- PHILIPSON, W.R. 1977. Ovular morphology and the classification of dicotyledons. In Kubitzki, K., ed. Flowering plants: evolution and classification of higher categories (Hamburg, 1976), pp. 123-140. Vienna.
- PHILIPSON, W.R. 1978. Araliaceae: growth forms and shoot morphology. In Tomlinson, P.B., and Zimmermann, M.H., eds. Tropical trees as living systems (Petersham, Mass. 1976), pp. 269-284. Cambridge, England.
- PHILIPSON, W.R. 1979. Araliaceae - I: [Introduction]. In Steenis, C.G.G. J. van, ed. Flora Malesiana, ser. I. vol. 9: 1-9. Alphen, the Netherlands.
- PHILIPSON, W.R., *et al.* 1980. The systematic position of *Aralidium* Miq. - a multidisciplinary study. Taxon 29: 391-416.
- RADFORD, A.E. *et al.* 1974. Vascular plant systematics. New York.
- TROLL, W. 1964-69. Die Infloreszenzen. Typologie und Stellung im Aufbau des Vegetationskörpers, Bd. 1, 2(1). Jena.

- TSENG, C.G. & SHOUP, J.R. 1978. Pollen morphology of *Schefflera*.
Amer. J. Bot. 65: 384-394.
- VIGUIER, R. 1906. Recherches anatomiques sur la classification
des Araliacées. Ann. Sci. Nat. Bot. IX, 4:
1-210.
- WEBERLING, F. 1965. Typology of inflorescences. J. Linn. Soc. Bot.
59: 215-221, 1 pl.
- WEBERLING, F. 1981. Morphologie der Blüten und der Blütenstände.
Ulmer. Stuttgart.
- ZEVI, B. 1978. The modern language of architecture. Seattle.



INFLORESCENCES - A FURTHER COMMENT^{*}

B.G. Briggs & L.A.S. Johnson
Royal Botanic Gardens, Sydney - 2000

A comparative study of inflorescences of Myrtaceae (Briggs and Johnson 1979) called for a review of general inflorescence structure, homology, and description. Work in *Eucalyptus* (Johnson 1972, 1976) and Proteaceae (Johnson and Briggs 1975) had previously led us to introduce the concepts of *uniflorescence* and *conflorescence*. Inflorescence systems in the Proteaceae are very different from those in the Myrtaceae, but we believe that our approach (developed mainly since our 1975 Proteaceae study) is applicable to both these families and to many others. Further extension, in particular to monocots, will call for amplification of some aspects, but we believe that it can be used with inflorescence systems generally. It depends on critical comparison and exact description, but is not bound to a comprehensive interpretative theory. Wide applicability depends on this relatively theory-free approach.

We gained much from Wilhelm Troll's systematization and clarification of inflorescence structures, but cannot accept the typological basis of his work, for both philosophical and practical reasons. It is useful to adopt many of Troll's descriptive terms and definitions, and to extend these logically where necessary. However, his concepts of *monotely*, *polytely*, *synflorescence*, and various others linked with these, are based on a typological equivalence theory that we have found to be inapplicable in many cases. Attempts to apply them in flexible and transitional cases, of which there are many, lead to equating organ-systems that are not phylogenetically or developmentally homologous, and separating some that are so.

Consequently, although inflorescence description is reputedly already overloaded with terminology, we found it necessary to introduce some new theory-free concepts and terms, in particular *anthotely* (termination of a shoot by a flower) and *blastotely* (termination by a non-floral bud). *Blastotely* encompasses *anauxotely* (shoot not growing on, i.e. functionally determinate) and *auxotely* (shoot growing on beyond the floriferous region).

* An invited paper for this issue the Australian Syst. Bot. Soc. Newsletter.

At the recent Inflorescence workshop, held by the Canberra Chapter of the Australian Systematic Botany Society (Hewson, 1981) it was notable that several botanists had studied inflorescences similar to those that led to our new concepts. In woody plants, and perhaps particularly in regions without seasonal extremes, variation is common in inflorescence position on the plant or on the shoot and in the extent of elaboration of inflorescence development. Particularly, there is variation in whether positionally equivalent axes are anathotelic or blastotelic. Of the rather few Australian investigations, it seems that a considerable proportion show such flexibility, and that the flexible condition is likely to be primitive (plesiomorphic) in relation to more fixed patterns.

Troll made a great contribution by stressing the integration of inflorescence structure with the pattern of growth of the vegetative parts of the plant (the *Unterbau*). Taking this a step further, there is need to consider inflorescence position within the growth units produced seasonally. We gave attention to this, defining the concept of a seasonal growth unit (SGU).

The Congress Inflorescence Symposium, the Canberra workshop, and various recent publications show a revival of interest in the critical description of inflorescences and in their morphological and evolutionary (not merely phylogenetic) interpretation. Always, of course, taking comparative ontogeny into account where it is known, inflorescence analysis can contribute much to knowledge of angiosperm growth patterns and to phylogenetic relationships. Nevertheless, parallelism and convergence (which are often clearly distinguishable in inflorescence study) are particularly common, and can often be related fairly clearly to adaptive syndromes.

References

- BRIGGS, B.G. & JOHNSON, L.A.S., 1979. Evolution in the Myrtaceae evidence from inflorescence structure. Proc. Linn. Soc. N. S. W. 102: 157-256.
- HEWSON, H., 1981. Inflorescence workshop Australian Syst. Bot. Soc. Newsletter 28: 11-12.
- JOHNSON, L.A.S. 1972. Evolution and classification in *Eucalyptus* (Presidential Address). Proc. Linn. Soc. N. S. W. 97: 11-29.
1976. Problems of species and genera in *Eucalyptus* (Myrtaceae). Plant Syst. Evol. 125: 155-167.
- & BRIGGS, B.G., 1975. On the Proteaceae - the evolution and classification of a southern family. J. Linn. Soc. London, Bot. 70: 83-182.
-

A.S.B.S. COUNCIL ELECTIONS

1982 - 1983 TERM

In accordance with the Constitution of the Society, nominations are called for all positions on the Council for 1982-1983 term of office: President, Vice-President, Secretary, Treasurer, 2 Councillors.

Each nominee must be proposed by two members and his/her acceptance of nomination must accompany the nomination itself. Nominations must be on the form at the back of this issue of the Newsletter or on a facsimile of that form.

All nominations must be in the hands of the Secretary, Ms J.G. West, Herbarium Australiense, C.S.I.R.O., P.O. Box 1600, Canberra 2600, A.C.T. by WEDNESDAY, 31st March 1982.

Ballot papers will be sent out in April and the results of the elections will be announced at the Society's General Meeting, in May 1982, in Brisbane.

Mr L.G. Adams
Herbarium Australiense
C.S.I.R.O.
P.O. Box 1600
CANBERRA CITY
A.C.T. 2601